

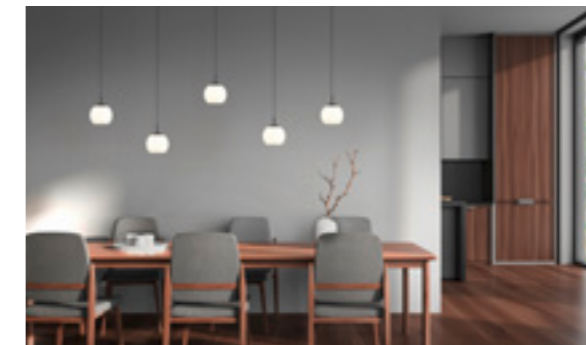

**YOUR
LIGHT
26**



INTERIOR LIGHTING
6 – 217



















BATHROOM
218 – 287



SYSTEMS
288 – 311



LIGHT IS OUTSIDE
312 – 383

-  eingebaute LED
built-in LED
-   Fassung für austauschbare Leuchtmittel
socket for exchangeable bulbs
-  dimmbar
dimmable
-  inklusive Dimmer
dimmer included
-  inklusive Fernbedienung
remote control included
-  Smart Home Steuerung optional
smart home control optionally
-  inklusive Schalter
switch on/off included
-  Höhe einstellbar
Height adjustable
-  stufenlose Höhenverstellung
height infinitely adjustable
-  EASY LIFT Höhenverstellung
EASY-LIFT height adjustment
-  MOTOR LIFT Elektrische Höhenverstellung
MOTOR-LIFT electric height adjustment
-  inklusive Bewegungsmelder
motion sensor included
-  Schutzart
ingress protection
-  IK... Stoßfestigkeitsgrad
impact protection
-  YL Plus
YOUR LIGHT Plus

Leuchtenübersicht Alphabetisch
lighting overview Alphabetical

ADD-IT	288–297
ADEO	170–171
AIR	354–355
ANOU	376–377
BAX	118–119
BELOS	154–155
BICA	320–323
BICA-Q	316–317
BICA-R	318–319
BONO	16–23
BUD	164–165
BUD 44	356–357
CANIO	158–159
CERTO	104–109
CHAZ	34–37
CILA	336–337
CIS	26–27
CITA	60–61
CLAIR	62–65
COPA	76–77
COSI	138–139, 264–267
DEEP	78–79
DEX	180–181
DORA	190–191
DORO	98–101
DUC	222–223
ENIO	188–189
ENNA	110–111
FLUTE	70–73
FOSCA	176–177
FREE	374–375
GAIA	260–263
GOTO	198–199
HELEN	130–131
ISOU	228–229
ISY	348–349
ITO	214–215
IVA	284–285
KARI	192–195
KEA	80–81
KETO	274–275
KIBO	372–373
KOBE	38–41
KORI	380–381

KYMO	272–273
LADO	254–255
LADO-S	256–257
LEDA	28–31
LETO	74–75
LEXX	94–95
LICA	148–149
LIDOS	46–51
LIV	120–123
LOMO	112–113
LOOM	230–237
LOOM 2	238–239
LOOPY	32–33
LUK	52–55
LUZ	166–167
LUZ 44	326–329
METIS	82–85
MILO	114–115
MONO	342–343
MORI	134–135
MORIS XL	378–379
NEX	90–93
NIO	182–185
NOG	204–205
NOK	252–253
NORSA	330–331
OKI	332–335
OLVI	276–277
ONTA	258–259
ONTO	210–211
OPPO	102–103
OSO	282–283
PALA	280–281
PAX	200–201
PEKA	370–371
PIER	344–345
PINA	66–67
PINO	160–163
POLE	86–87
PONTO	240–241
PONTO-S	242–243
POSH	324–325
RACK	144–147
RIWA	196–197

ROK	42–45
ROMO	58–59
ROTA	202–203
SALLY	88–89
SAO	124–129
SCALA	352–353
SENT	212–213
SID	286–287
SIMO	156–157
SIN	350–351
SIRI	174–175
SIRI 44	366–367
SIRI 44-L	368–369
SIRI 44-R	364–365
SKA	216–217
SKY	338–341
SLATE	244–247
SONA	136–137
SOU	186–187
SWIFT	360–361
TAMO	150–151
TANA	152–153, 278–279
TENDO	346–347
THEIA	248–251
TOCO	168–169
TOCO 44	358–359
TOKI	24–25
TOZY	362–363
TUDO	206–209
TURA	132–133
URIA	56–57
VANA	14–15
VANA-M	12–13
VAYA	116–177
VENTA	96–97
VID	172–173
VIDO	224–227
VIGO	298–311
VIRTO	140–143
YONA	178–179
ZAYA	68–69
ZELO	268–271

INDEX

INTERIOR LIGHTING



Leuchtenübersicht Innenleuchten
Overview interior lighting

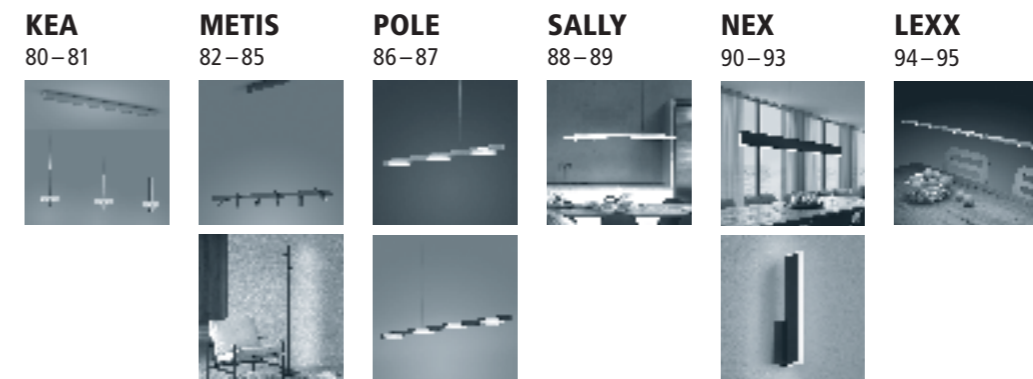
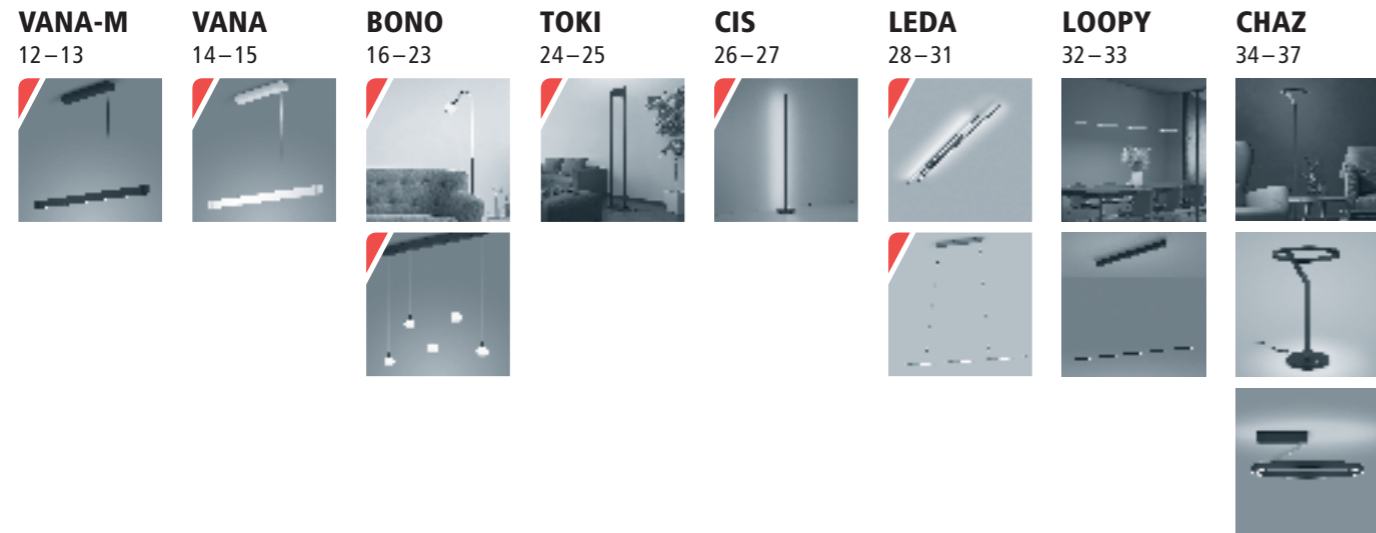

INDEX

NEW

Leuchtenübersicht Innenleuchten
Overview interior lighting

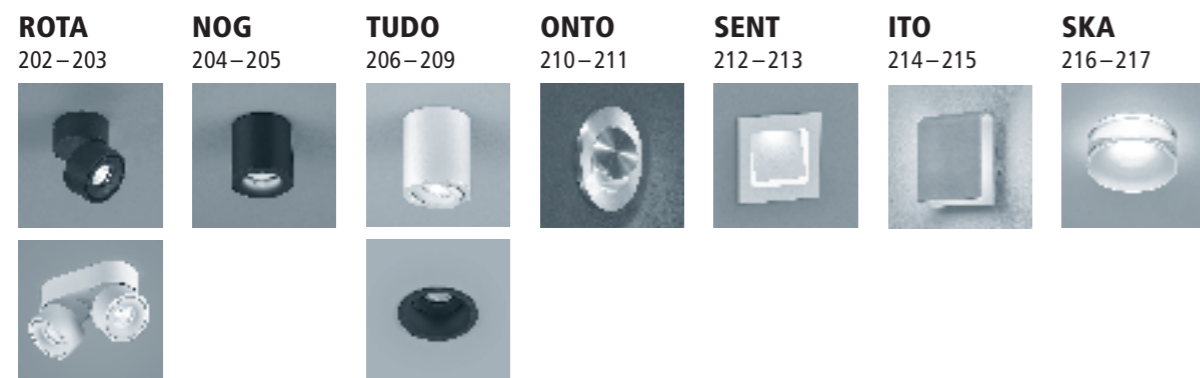
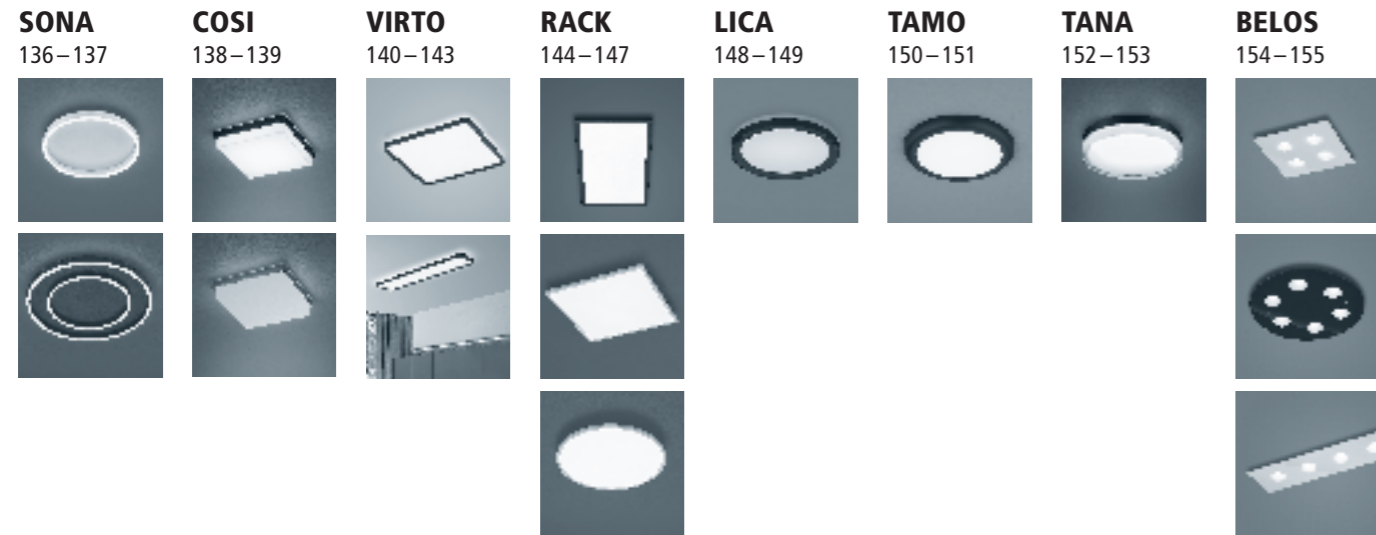

INDEX

NEW



MOTOR-LIFT
 Komfortable Höhenverstellung durch integrierten Motor
 Comfortable height adjustment by integrated motor

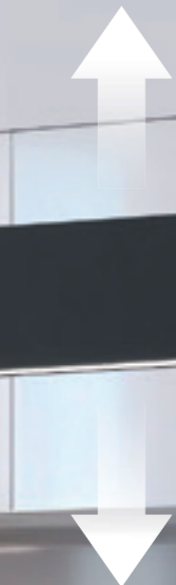

mattschwarz / black mat
36/2610.22
 coffee
36/2610.70



VANA-M

LED CCT incl. MOTOR LIFT IP20 VL+

elektrische Höhenverstellung
 Farbtemperatursteuerung 2200 - 6500 K
 Lichtverteilung 75% direkt - 25% indirekt
 electric height adjustment
 Colour temperature control 2200 - 6500 K
 light distribution 75% direct - 25% indirect

40 W, B 5400 / N 3490 lm, 2200 - 6500 K, CRI > 90

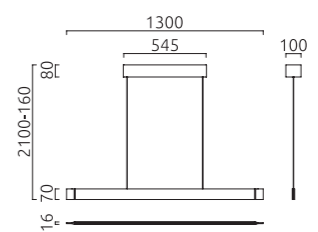



VANA



Farbtemperatursteuerung 2200 - 6500 K
 Lichtverteilung 75% direkt - 25% indirekt
 Colour temperature control 2200 - 6500 K
 light distribution 75% direct - 25% indirect

40 W, B 5400 / N 3490 lm, CRI > 90



www.helestra.de/vana

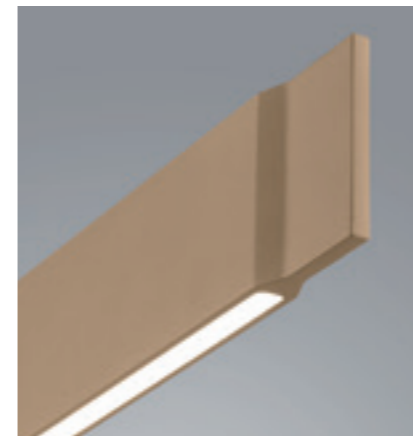

mattweiß / white mat
36/2500.07
 mattschwarz / black mat
36/2500.22
 coffee
36/2500.70

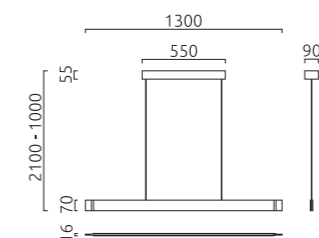

mattweiß / white mat
36/2500.07-K
 mattschwarz / black mat
36/2500.22-K
 coffee
36/2500.70-K

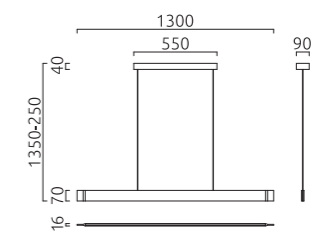



BONO



Opalglas weiß
glass opal white

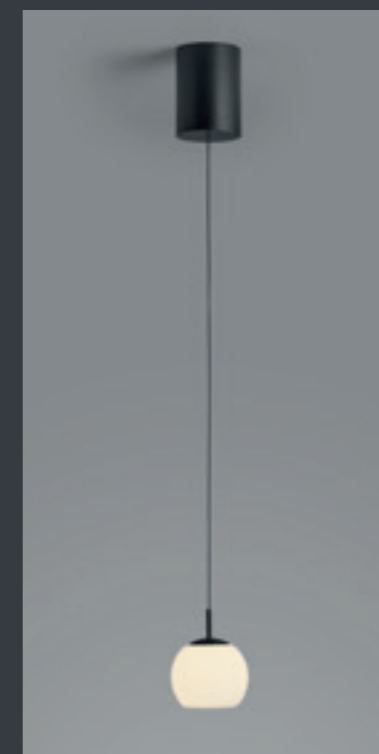

10 W, 2700 K, B 1320 / N 1050 lm, CRI > 90

mattschwarz / black mat

16/2501.22

coffee

16/2501.70

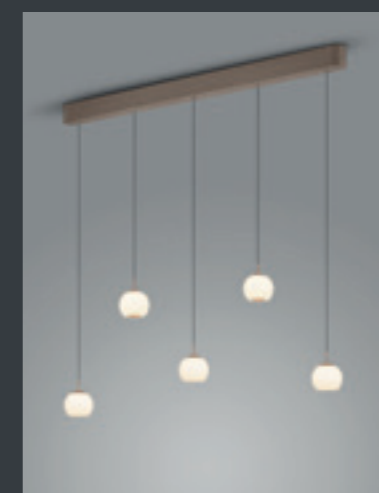

42 W, 2700 K, B 5600 / N 4450 lm, CRI > 90

mattschwarz / black mat

56/2501.22

coffee

56/2501.70

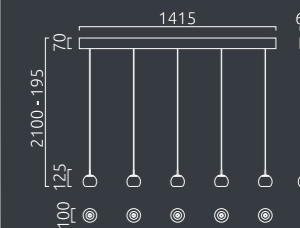

BONO



Opalglas weiß
glass opal white

42 W, 2700 K, B 5600 / N 4450 lm, CRI > 90



mattschwarz / black mat
56/2551.22

coffee
56/2551.70

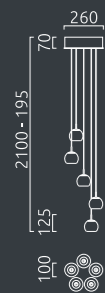

BONO

LED  IP20 

Opalglas weiß
glass opal white

8 W, 2700 K, B 1120 / N 890 lm, CRI > 90

mattschwarz / black mat
17/2501.22

coffee
17/2501.70

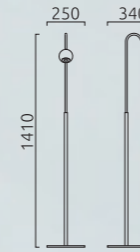

zusätzliches Leselicht separat steuerbar
Kopf dreh- und schwenkbar
additional spotlight can be controlled separately
head rotatable and tiltable

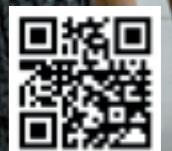



BONO



Opalglas weiß
glass opal white

15 W, 2700 K, B 1960 / N 1550 lm, CRI > 90



mattschwarz / black mat
17/2609.22

coffee
17/2609.70



www.helestra.de/bono

TOKI



15+6 W, 2700 K, B 2660 / N 2040 lm, CRI > 90

mattschwarz / black mat
27/2606.22

coffee
27/2606.70

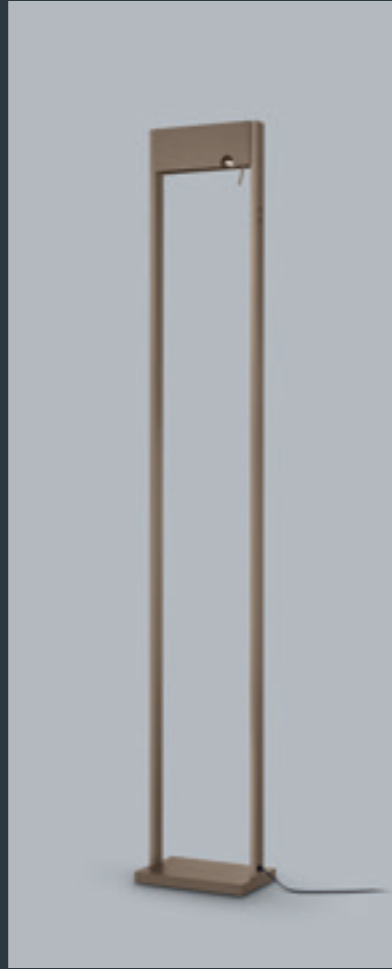

www.helestra.de/toki



CIS

LED  IP20 

70 W, 2700 K, B 7460 / N 3240 lm, CRI > 90



mattschwarz / black mat
27/2618.22

coffee
27/2618.70





LEDA

LED  IP20

Acryldiffusor satiniert
acrylic diffuser satinised

24 W, 2700 K, B 2860 / N 1920 lm, CRI > 90



coffee
25/2602.70

titangrau eloxiert / titanium grey anodized
25/2602.80

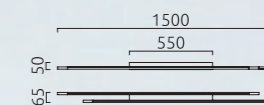

LEDA

LED   IP20

Acryldiffusor satiniert
acrylic diffuser satinised

12 W, 2700 K, B 1430 / N 960 lm, CRI > 90

coffee

16/2600.70

titangrau eloxiert / titanium grey anodized

16/2600.80

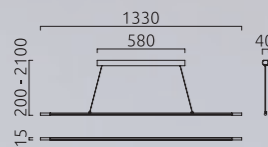

14 W, 2700 K, B 1670 / N 1120 lm, CRI > 90

coffee

16/2601.70

titangrau eloxiert / titanium grey anodized

16/2601.80

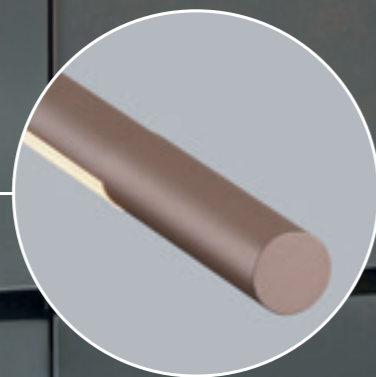
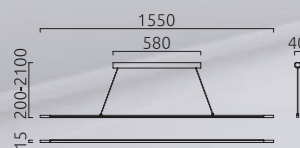

LOOPY

LED   IP20

22 W, 2700 K, B 2370 / N 970 lm, CRI > 90

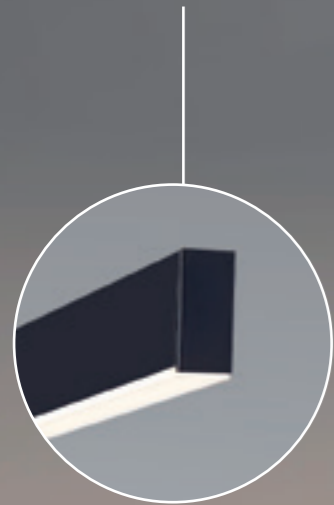

mattgold / gold mat
16/2109.02

mattschwarz / black mat
16/2109.22

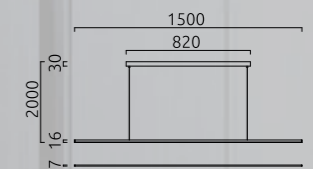

CHAZ

LED  IP20 

Acryldiffusor satiniert
acrylic diffuser satinised



12 W, 2700 K, B 1360 / N 820 lm, CRI > 90

mattschwarz / black mat

19/2402.22

mattschwarz - mattgold / black mat - gold mat

19/2402.28

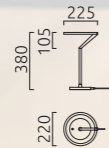

13,5 W, 2700 K, B 1530 / N 920 lm, CRI > 90

mattschwarz / black mat

17/2402.22

mattschwarz - mattgold / black mat - gold mat

17/2402.28



25 W, 2700 K, B 2840 / N 1930 lm, CRI > 90

Lichtverteilung direkt / indirekt
light distribution direct / indirect

mattschwarz / black mat

27/2402.22

mattschwarz-mattgold / black mat-gold mat

27/2402.28

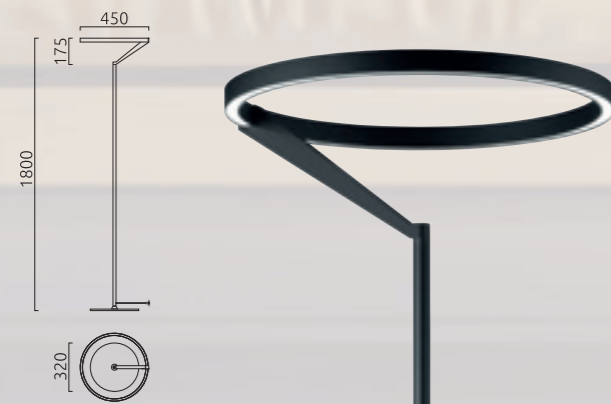



CHAZ

LED  IP20  **YL**
Plus

Acryldiffusor satiniert
acrylic diffuser satinised

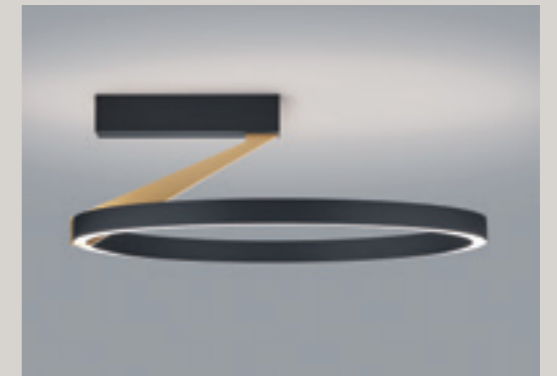

25 W, 2700 K, B 2840 / N 1930 lm, CRI > 90

Lichtverteilung direkt / indirekt
light distribution direct / indirect

mattschwarz / black mat
25/2402.22

mattschwarz - mattgold / black mat - gold mat
25/2402.28

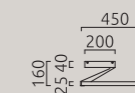

11 W, 2700 K, B 1100 / N 660 lm, CRI > 90

mattschwarz / black mat
18/2402.22

mattschwarz - mattgold / black mat - gold mat
18/2402.28

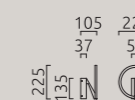

KOBE



30° Abstrahlwinkel
30° beam angle

11 W, 2700 K, B 1120 / N 840 lm, CRI > 90

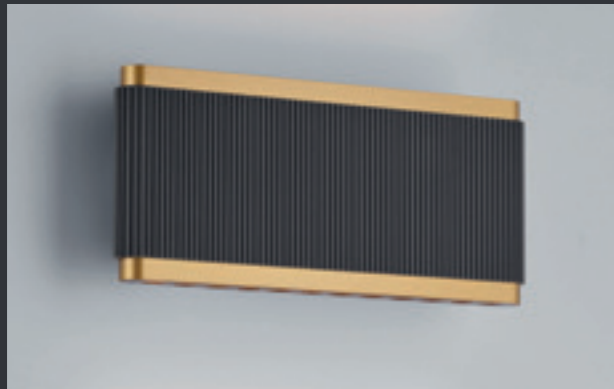

mattweiß / white mat
28/2604.07

mattschwarz - mattgold / black mat - gold mat
28/2604.28

55, 225
18 4: 1

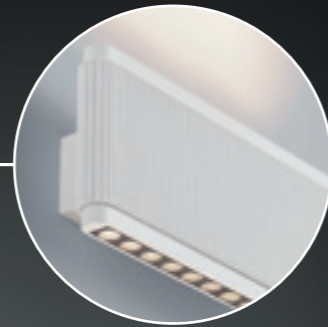



KOBE

LED   IP20

30° Abstrahlwinkel
30° beam angle

42 W, 2700 K, B 4510 / N 2750 lm, CRI > 90



mattschwarz - mattgold / black mat - gold mat
66/2604.28

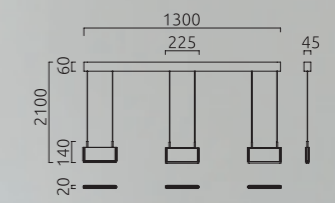

ROK



Lichtaustritt verstellbar 20-60°
beam angle adjustable 20-60°

10 W, 2700 K, B 1280 / N 1020 lm, CRI > 90



mattweiß / white mat
26/2502.07

mattschwarz-mattgold / black mat-gold mat
26/2502.28



mattweiß / white mat
25/2502.07

mattschwarz-mattgold / black mat-gold mat
25/2502.28



ROK

LED    IP20

Lichtaustritt verstellbar 20-60°
beam angle adjustable 20-60°

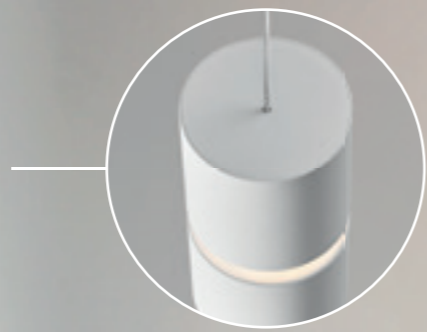

30 W, 2700 K, B 3840 / N 3060 lm, CRI > 90

mattweiß / white mat

66/2502.07

mattschwarz-mattgold / black mat-gold mat

66/2502.28

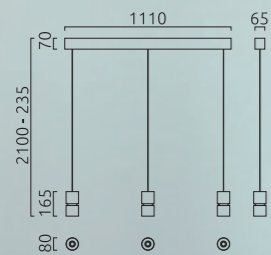

www.helestrade.de/rok

LIDOS



LIDOS

LED   IP20

Acrylglas satiniert
acrylic glass satinised

11 W, 2700 K, B 1160 / N 870 lm, CRI > 90

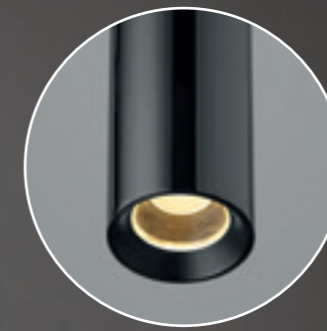

2100 - 350
110
240
45
180

mattschwarz-mattgold / black mat-gold mat
16/2503.28

schwarzchrom / black chrome
16/2503.64



LIDOS



Acrylglas satiniert
acrylic glass satinised

55 W, 2700 K, B 5880 / N 4350 lm, CRI > 90

mattschwarz-mattgold / black mat-gold mat
56/2503.28

schwarzchrom / black chrome
56/2503.64

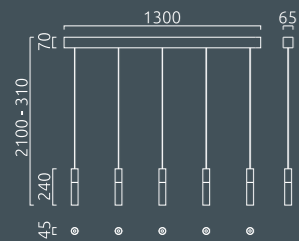



LUK

LED    IP20

12 W, 2700 K, B 1100 / N 720 lm, CRI > 90
 mattschwarz - mattgold / black mat - gold mat
26/2615.28

coffee
26/2615.70

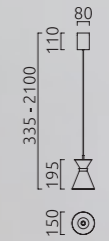

30 W, 2700 K, B 3300 / N 2160 lm, CRI > 90
 mattschwarz - mattgold / black mat - gold mat
66/2615.28

coffee
66/2615.70

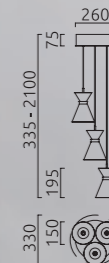

LUK

LED  IP20

10 W, 2700 K, B 1040 / N 680 lm, CRI > 90
mattschwarz - mattgold / black mat - gold mat
27/2615.28
coffee
27/2615.70

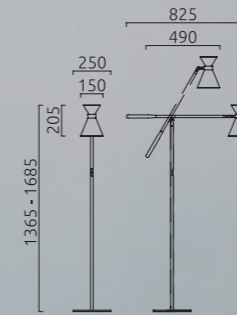

www.helestra.de/luk

URIA

E27  IP20 

mattschwarz - blattgold
black mat - gold leaf

1x E27
17/2310.28

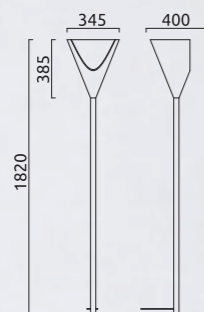

Leuchtmittel nicht im Lieferumfang
bulb not included



ROMO



25 W, 2700 K, B 2340 / N 1810 lm, CRI > 90

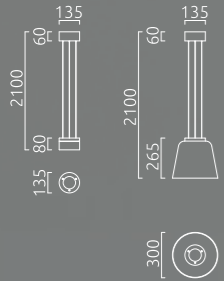

schwarzchrom / black chrome
16/2404.64

schwarzchrom / black chrome
Glas rauchgrau / glass smokey grey
16/2404.64/5346

mattschwarz - mattgold / black mat - gold mat
16/2404.28

mattschwarz - mattgold / black mat - gold mat
Glas rauchgrau / glass smokey grey
16/2404.28/5346

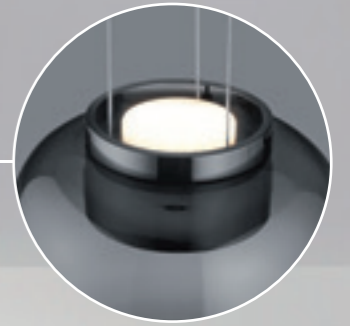

CITA

LED    IP20 

mundgeblasenes Glas
mouth-blown glass

38 W, 2700 K, B 4390 / N 2380 lm, CRI > 90

chrom / chrome
Glas - klar / glass - clear
16/2306.04/5328

mattschwarz / black mat
Glas grau / glass grey
16/2306.22/5329

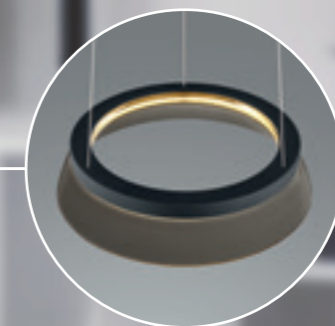
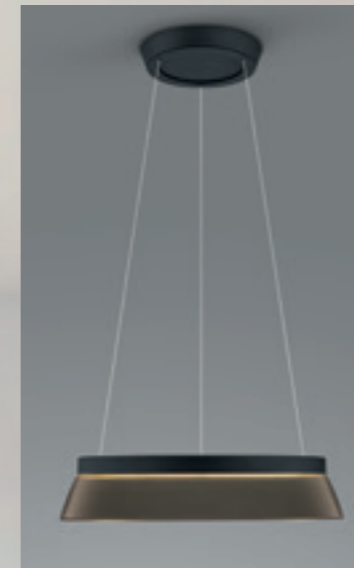
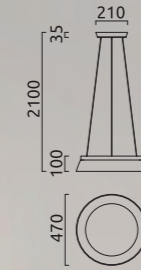

CLAIR



Kristallglas rauchgrau
crystal glass smokey grey

17 W, 2700 K, B 1750 / N 1360 lm, CRI > 90

mattschwarz / black mat

16/2403.22

mattschwarz - mattgold / black mat - gold mat

16/2403.28



www.helestra.de/clair

CLAIR

LED    

Kristallglas rauchgrau
crystal glass smokey grey



27 W, 2700 K, B 2780 / N 2170 lm, CRI > 90

mattschwarz / black mat

36/2403.22

mattschwarz - mattgold / black mat - gold mat

36/2403.28

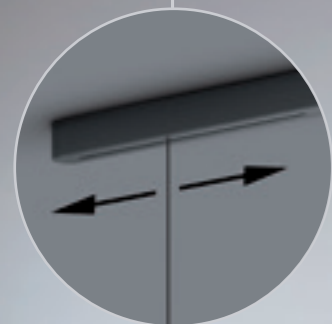
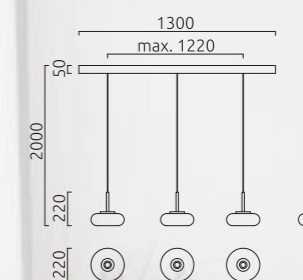



PINA



mattschwarz
black mat

21 W, 2700 K, B 2210 / N 1760 lm, CRI > 90

Glas grau / glass grey
16/2314.22/5326

Glas bronze / glass bronze
16/2314.22/5327

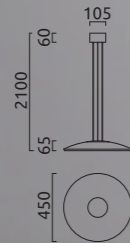

ZAYA

E27 ↑ IP20 YL Plus

schwarzchrom
Kristallglas rauchgrau
black chrome
crystal glass smokey grey

Leuchtmittel nicht im Lieferumfang
bulb not included

1 x E27
16/2405.64/5345

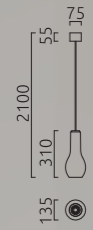

3 x E27
36/2405.64/5345

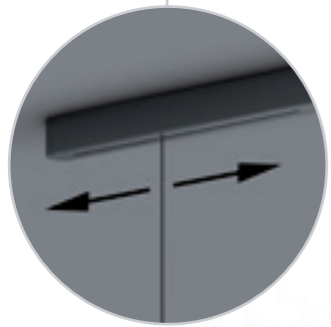
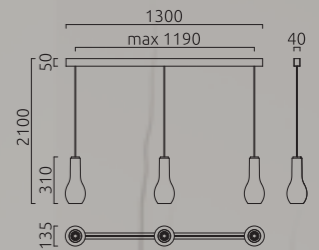

FLUTE

LED   IP20

Acryldiffusor satiniert
optional Glas klar oder grau
acrylic diffuser satinised
optional glass clear or grey

Gläser bitte separat bestellen /
please order glasses separately
5284 Glas klar / glass clear
5285 Glas grau / glass grey

8 W, 2800 K, B 880 / N 570 lm, CRI > 90

chrom / chrome
16/2001.04

schwarzchrom / black chrome
16/2001.64

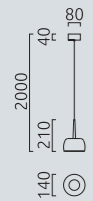

19 W, 2800 K, B 2140 / N 1320 lm, CRI > 90

chrom / chrome
36/2002.04

schwarzchrom / black chrome
36/2002.64

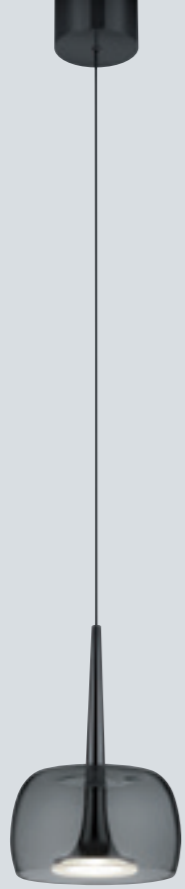
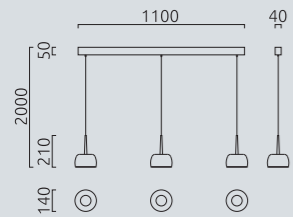

FLUTE

LED   IP20

Acryldiffusor satiniert
acrylic diffuser satinised

8 W, 2800 K, B 880 / N 570 lm, CRI > 90

chrom / chrome
16/2001.04

schwarzchrom / black chrome
16/2001.64



19 W, 2800 K, B 2140 / N 1320 lm, CRI > 90

chrom / chrome
36/2002.04

schwarzchrom / black chrome
36/2002.64

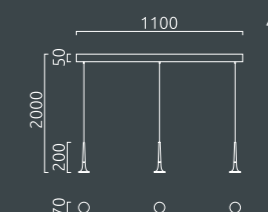

LETO

LED ↑ IP20 YL Plus

mattschwarz
Glas grau
black mat
glass grey

6 W, 2700 K, B 440 / N 380 lm, CRI > 90

16/2315.22/5324

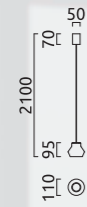

16/2315.22/5325

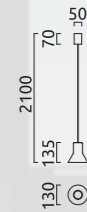



COPA

LED IP20



16 W, 2700 K, B 1530 / N 1130 lm, CRI > 90
mattweiß / white mat

Reflektor / reflector
16/2302.07-07 weiß / white
16/2302.07-09 gold / gold
16/2302.07-22 schwarz / black

mattschwarz / black mat
 Reflektor / reflector
16/2302.22-07 weiß / white
16/2302.22-09 gold / gold
16/2302.22-22 schwarz / black



DEEP

LED   IP20

Glas teilsatiniert
glass partially satinised

9 W, 2700 K, B 1040 / N 790 lm, CRI > 90

mattgold / gold mat
16/2110.09

mattschwarz / black mat
16/2110.22

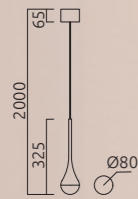

KEA



Glas opal weiß
Abstrahlwinkel 50°
glass opal white
beam angle 50°



32 W, 2700 K, B 3450 / N 1710 lm, CRI > 90

mattnickel / nickel mat

66/2108.06/5303

mattschwarz / black mat

66/2108.22/5303

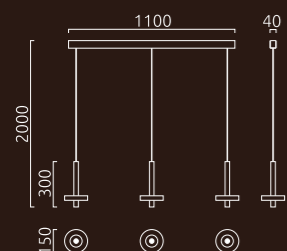

METIS

LED    IP20 

schwenkbar
tiltable

43 W, 2700 K, B 4980 / N 3480 lm, CRI > 90

mattschwarz / black mat
96/2311.22

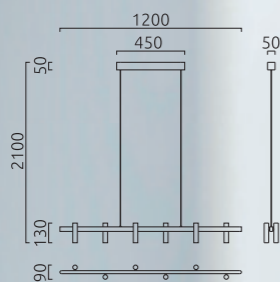

METIS

LED  IP20 

schwenkbar
tiltable

18 W, 2700 K, B 2110 / N 1780 lm, CRI > 90

mattschwarz / black mat
27/2311.22





POLE

LED    IP20

Glas satiniert
glass satinised

28 W, 2700 K, B 3940 / N 2160 lm, CRI > 90

mattnickel eloxiert / nickel mat anodised
36/1901.18

mattschwarz eloxiert / black mat anodised
36/1901.22

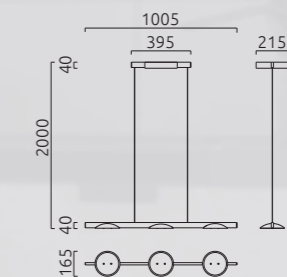

41 W, 2700 K, B 5250 / N 2880 lm, CRI > 90

mattnickel eloxiert / nickel mat anodised
46/1901.18

mattschwarz eloxiert / black mat anodised
46/1901.22

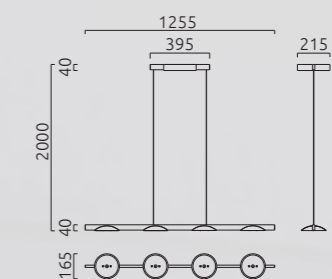

SALLY

LED    IP20



mattnickel eloxiert
Glas satiniert
nickel mat anodised
glass satinised

22 W, 2800 K, B 2460 / N 1890 lm, CRI > 90
26/1641.27/5210

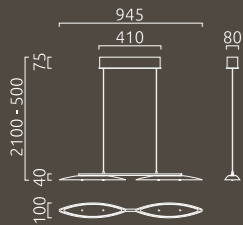

www.helestra.de/sally

NEX



mattschwarz
Acryldiffusor satiniert
black mat
acrylic diffuser satinised



45 W, 2700 K, B 5900 / N 2820 lm, CRI > 90
16/2007.22

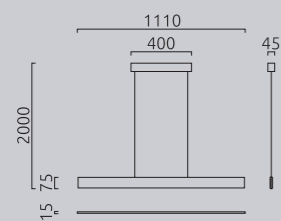



NEX

LED IP20

mattschwarz
Acryldiffusor satiniert
black mat
acrylic diffuser satinised



12 W, 2700 K, B 1620 / N 1150, CRI > 90
18/2007.22

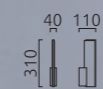

LEXX

LED   IP30

mattnickel eloxiert
Acryldiffusor satiniert
nickel mat anodised
acrylic diffuser satinised

23 W, 2700 K, B 2630 / N 1820 lm, CRI > 85



16/1504.19

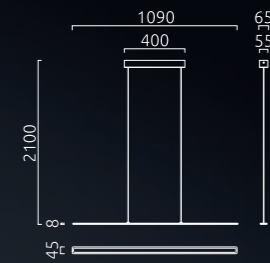

16/1644.19

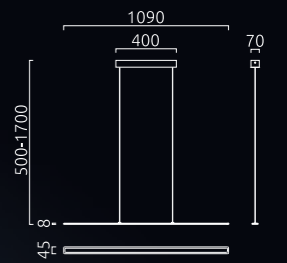

VENTA

LED  IP30

Acryldiffusor satiniert
acrylic diffuser satinised

31 W, 2700 K, B 4790 / N 2690 lm, CRI > 90

mattnickel eloxiert / nickel mat anodised
17/1505.19

mattschwarz / black mat
17/1505.22

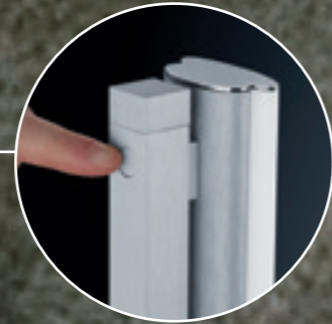
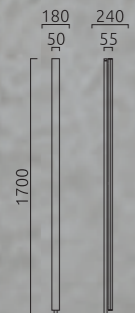

DORO

E27   IP20

1 x E27

Schirm Acryl weiß
shade acrylic white

weiß - chrom / white - chrome
17/1240.84/5045

schwarz - chrom / black - chrome
17/1240.34/5045

Schirm Acryl schwarz
shade acrylic black

schwarz - chrom / black - chrome
17/1240.34/5096

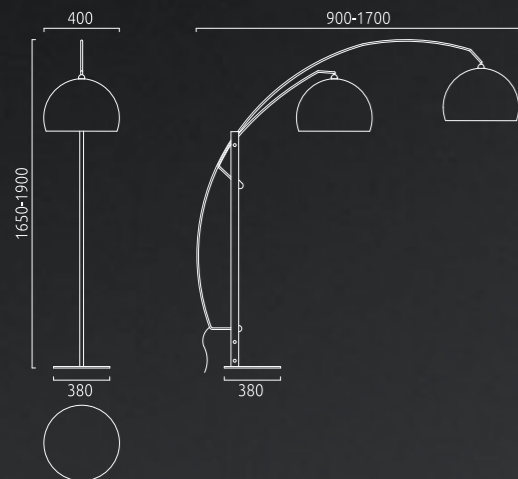

Leuchtmittel nicht im Lieferumfang
bulb not included



DORO

E27 ↑ IP20

mattschwarz
black mat

1 x E27

Textilkabel schwarz / textile cord black

Ø 40

16/2340.22/5045 Acryl weiß / acrylic white
16/2340.22/5096 Acryl schwarz / acrylic black

Ø 50

16/2340.22/5097 Acryl weiß / acrylic white
16/2340.22/5098 Acryl schwarz / acrylic black

Textilkabel rot / textile cord red

Ø 40

16/2340.75/5045 Acryl weiß / acrylic white
16/2340.75/5096 Acryl schwarz / acrylic black

Ø 50

16/2340.75/5097 Acryl weiß / acrylic white
16/2340.75/5098 Acryl schwarz / acrylic black

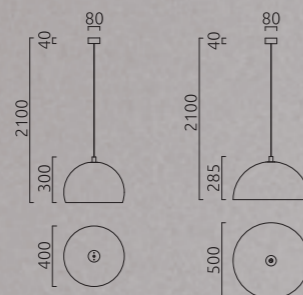

Leuchtmittel nicht im Lieferumfang
bulb not included



OPPO

E27  IP20

mattschwarz-schwarzchrom
Stoffschirm schwarz
black mat-black chrome
fabric shade black

1 x E27
Leuchtmittel nicht im Lieferumfang / bulb not included



19/2507.43

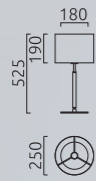

17/2507.43



CERTO

E27  IP20

mattschwarz - chrom
black mat - chrome

1 x E27

Schirm Chintz weiß / shade chintz white
17/1849.34/9290

Schirm Chintz anthrazit / shade chintz anthracite
17/1849.34/9289



Leuchtmittel nicht im Lieferumfang
bulb not included



CERTO

E27 ↑ IP20

chrom
dreh- und schwenkbar
chrome
rotatable and tiltable

1 x E27



Schirm Chintz weiß / shade chintz white
16/1847.04/9290



Schirm Chintz anthrazit / shade chintz anthracite
16/1847.04/9289



Schirm Chintz mocca / shade chintz mocca
16/1847.04/9288

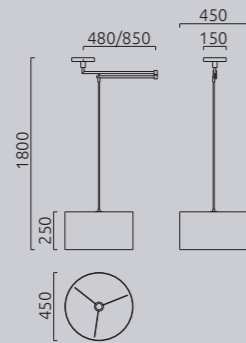

Schirm Chintz weiß / shade chintz white
16/1847.04/9276



Schirm Chintz anthrazit / shade chintz anthracite
16/1847.04/9283

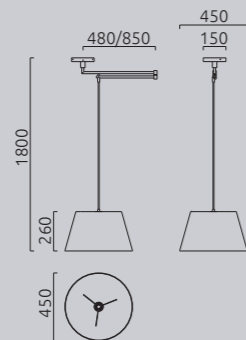

Leuchtmittel nicht im Lieferumfang
bulb not included





CERTO

E27 ↑ IP20

chrom
dreh- und schwenkbar
chrome
rotatable and tiltable

2 x E27



Schirm Chintz weiß / shade chintz white
26/1847.04/9290

Schirm Chintz anthrazit / shade chintz anthracite
26/1847.04/9289

Schirm Chintz mocca / shade chintz mocca
26/1847.04/9288



Schirm Chintz weiß / shade chintz white
26/1847.04/9276

Schirm Chintz anthrazit / shade chintz anthracite
26/1847.04/9283

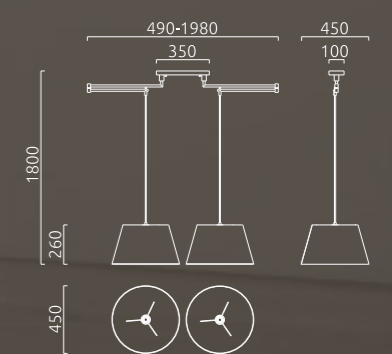

ENNA

E14 E27  IP20

blanknickel
Schirm, Chintz weiß
nickel polished
shade, chintz white



1 x E14
19/1138.10

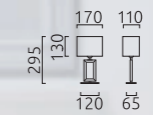

1 x E27
19/1139.10

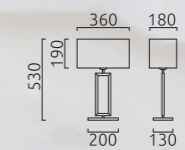

Leuchtmittel nicht im Lieferumfang
bulb not included



LOMO

LED   IP20

mattweiß
white mat

34 W, 2800 K, B 4030 / N 2500 lm, CRI > 90

Schirm Chintz weiß / shade chintz white
15/1800.07/9277

Schirm Chintz mocca / shade chintz mocca
15/1800.07/9278

Schirm Chintz anthrazit / shade chintz anthracite
15/1800.07/9281

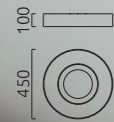

MILO

LED  IP20

mattschwarz
Opalglas weiß
inkl. 3-Stufen Touchdimmer

black mat
glass opal white
incl. 3-step touch dimmer



13 W, 2700 K, B 1370 / N 680 lm, CRI > 90
19/2611.22



18 W, 2700 K, B 1890 / N 940 lm, CRI > 90
19/2631.22



VAYA

LED  IP20

Acrylglas satiniert
acrylic glass satinised

18 W, 2700 K, B 1940 / N 830 lm, CRI > 90

mattweiß / white mat
39/2612.07

mattschwarz / black mat
39/2612.22

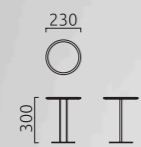



BAX

LED  IP20

Acryldiffusor satiniert
inkl. 3-Stufen Touchdimmer
acrylic diffuser satinised
incl. 3-step touch dimmer

10 W, 2700 K, B 1220 / N 780 lm, CRI > 85

mattweiß / white mat
19/1943.07

200 
170 



LIV

LED Casambi IP30

Acryldiffusor satiniert
acrylic diffuser satinised



10 W, 2900 K, B 1260 / N 460 lm, CRI > 90

mattweiß / white mat
15/1732.07

mattschwarz / black mat
15/1732.22



17 W, 2900 K, B 2090 / N 740 lm, CRI > 90

mattweiß / white mat
15/1632.07

mattschwarz / black mat
15/1632.22

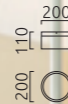

36 W, 2900 K, B 4630 / N 2340 lm, CRI > 90

mattweiß / white mat
25/1734.07

mattschwarz / black mat
25/1734.22

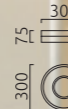



LIV

LED    IP20

Acryldiffusor satiniert
acrylic diffuser satinised



49 W, 2900 K, B 5310 / N 3650 lm, CRI > 90

mattweiß / white mat

26/1692.07

mattschwarz / black mat

26/1692.22



70 W, 2900 K, B 7710 / N 5070 lm, CRI > 90

mattweiß / white mat

26/1792.07

mattschwarz / black mat

26/1792.22

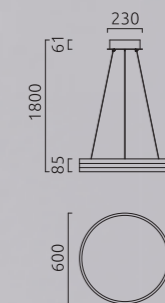

SAO



Acryldiffusor satiniert
acrylic diffuser satinised



40 W, 2700 K, B 4470 / N 3710 lm, CRI > 90

mattweiß / white mat

26/2430.07

mattschwarz / black mat

26/2430.22



60 W, 2700 K, B 6700 / N 5550 lm, CRI > 90

mattweiß / white mat

26/2431.07

mattschwarz / black mat

26/2431.22





SAO

LED Casambi IP20 YL Plus

Acryldiffusor satiniert
acrylic diffuser satinised

40 W, 2700 K, B 4470 / N 3710 lm, CRI > 90

mattweiß / white mat
25/2330.07

blattgold / gold leaf
25/2330.09

mattschwarz / black mat
25/2330.22

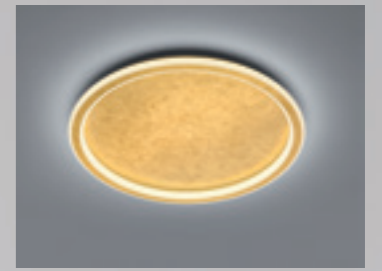

60 W, 2700 K, B 6700 / N 5550 lm, CRI > 90

mattweiß / white mat
25/2331.07

blattgold / gold leaf
25/2331.09

mattschwarz / black mat
25/2331.22



SAO

LED   IP20 

Acryldiffusor satiniert
mit Spiegel Ø 330 mm
acrylic diffuser satinised
with mirror Ø 330 mm

40 W, 2700 K, B 4470 / N 3710 lm, CRI > 90

mattweiß / white mat

28/2330.07-50

blattgold / gold leaf

28/2330.09-50

mattschwarz / black mat

28/2330.22-50





HELEN

LED   IP20 

Acryldiffusor satiniert
acrylic diffuser satinised

32 W, 2700 K, B 3440 / N 1610 lm, CRI > 90

mattweiß / white mat

Reflektor / reflector

18/2410.07-07 weiß / white

18/2410.07-09 blattgold / gold leaf

18/2410.07-50 Spiegel / mirror Ø 405 mm

mattschwarz / black mat

Reflektor / reflector

18/2410.22-07 weiß / white

18/2410.22-09 blattgold / gold leaf

18/2410.22-50 Spiegel / mirror Ø 405 mm

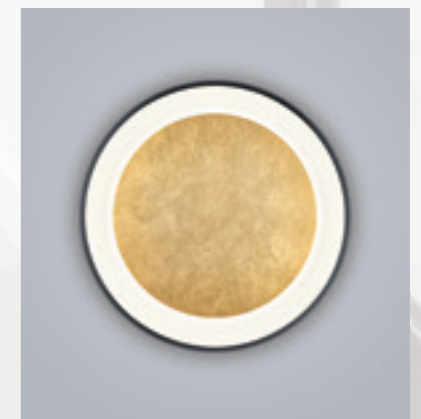
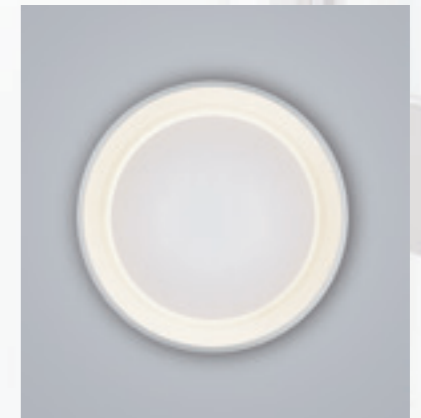
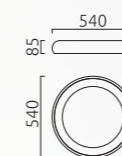

TURA

LED  IP20 

mattschwarz-blattgold
black mat-gold leaf

60 W, 2700 K, B 6200 / N 2790 lm, CRI > 90

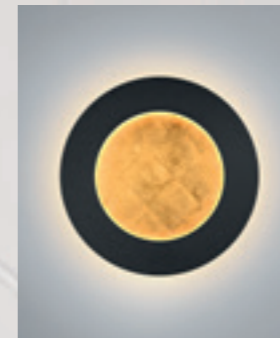

18/2514.28

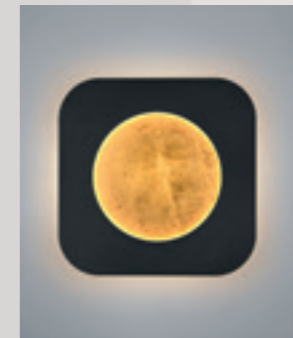
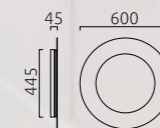

18/2515.28

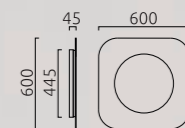

inkl. Zuleitung mit Netzstecker / incl. supply line with mains plug
(L 3,00 m)



18/2514.28-K



18/2515.28-K





MORI

LED CCT Casambi IP20

Farbtemperatur einstellbar 2700 oder 3000 K
colour temperature adjustable 2700 or 3000 K

50 W, B 5450 / N 3820 lm, CRI > 90



mattweiß / white mat
15/2504.07

mattschwarz-blattgold / black mat-gold leaf
15/2504.28





SONA

LED   IP20

Acryldiffusor satiniert
acrylic diffuser satinised



24 W, 2900 K, B 2900 / N 2040 lm, CRI > 85

mattschwarz / black mat
15/1993.22

mattweiß / white mat
15/1993.07

blattgold / gold leaf
15/1993.09

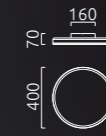

60 W, 2900 K, B 6700 / N 4690 lm, CRI > 85

mattschwarz / black mat
25/1994.22

mattweiß / white mat
25/1994.07

blattgold / gold leaf
25/1994.09





COSI

LED  IP30

Glas satiniert - Kanten poliert
glass satinised - edges polished



7 W, 2900 K, B 1070 / N 610 lm, CRI > 90

chrom / chrome

15/1905.04

mattnickel / nickel mat

15/1905.06

mattschwarz / black mat

15/1905.22



12 W, 2900 K, B 1780 / N 1020 lm, CRI > 90

chrom / chrome

15/1906.04

mattnickel / nickel mat

15/1906.06

mattschwarz / black mat

15/1906.22



26 W, 2900 K, B 3220 / N 1840 lm, CRI > 90

chrom / chrome

15/1907.04

mattnickel / nickel mat

15/1907.06

mattschwarz / black mat

15/1907.22

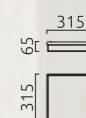



VIRTO



prismatischer Diffusor < 19
Lichtverteilung 85 % direkt - 15 % indirekt
prismatic diffuser UGR < 19
light distribution 85 % direct - 15 % indirect

50 W, 3000 K, B 5850 / N 2870 lm, CRI > 85

mattweiß / white mat
15/2416.07
15/2416.07-DALI

mattschwarz / black mat
15/2416.22
15/2416.22-DALI

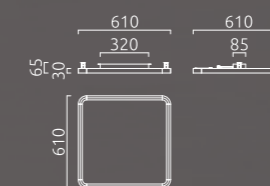

Deckengehäuse flexibel hinter oder neben der
Leuchte montierbar
housing can be mounted flexibly behind or next to
the luminaire



VIRTO



prismatischer Diffusor <math>< 19</math>
Lichtverteilung 85 % direkt - 15 % indirekt
prismatic diffuser UGR <math>< 19</math>
light distribution 85 % direct - 15 % indirect

50 W, 3000 K, B 5850 / N 2870 lm, CRI > 85



Deckengehäuse flexibel hinter oder neben der Leuchte montierbar
housing can be mounted flexibly behind or next to the luminaire

mattweiß / white mat

15/2417.07

15/2417.07-DALI

mattschwarz / black mat

15/2417.22

15/2417.22-DALI

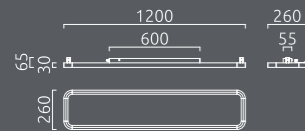



RACK

LED  IP20

Acryldiffusor satiniert
acrylic diffuser satinised

22 W, 2900 K, B 2460 / N 1730 lm, CRI > 90

mattweiß / white mat
15/2254.07

blattgold / gold leaf
15/2254.09

mattschwarz / black mat
15/2254.22

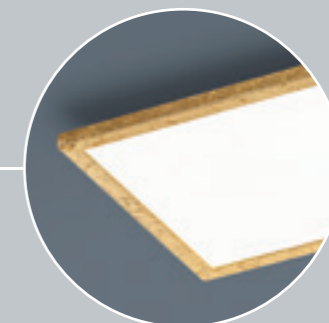
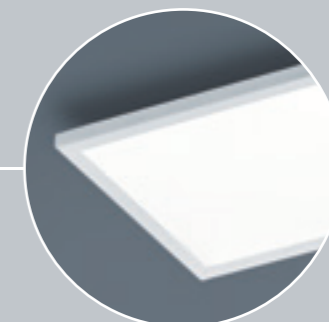
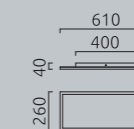

RACK



Acryldiffusor satiniert
acrylic diffuser satinised

21 W, 2900 K, B 2550 / N 1800 lm, CRI > 90

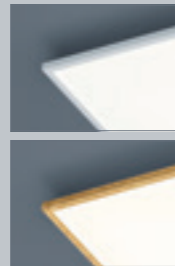

mattweiß / white mat
15/1954.07

blattgold / gold leaf
15/1954.09

mattschwarz / black mat
15/1954.22

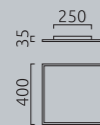

mattweiß / white mat
15/1956.07

blattgold / gold leaf
15/1956.09

mattschwarz / black mat
15/1956.22





LICA



mattschwarz
Acryldiffusor satiniert
Lichtverteilung direkt / indirekt
Abstrahlwinkel 120°

black mat
acrylic diffuser satinised
light distribution direct / indirect
beam angle 120°



30 W, B 3280 / N 2590/2680/2740 lm, CRI > 90
15/2210.22

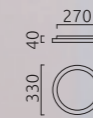

50 W, B 5480 / N 4190/4510/4790 lm, CRI > 90
15/2211.22

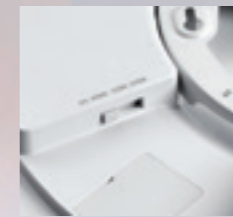
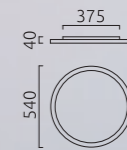

cct 2700 / 3500 / 4000 K
fix einstellbar an der Leuchte oder
variabel über Wandschalter (BS)
constantly adjustable on luminaire or
variable by wall switch (BS)



TAMO

LED IP54 YL Plus

Deckeneinbauleuchte
Acryldiffusor satiniert
Abstrahlwinkel 120°
recessed mounted luminaire
acrylic diffuser satinised
beam angle 120°

max. B 1940 / N 1650 lm, CRI > 85



mattschwarz / black mat
15/2301.22

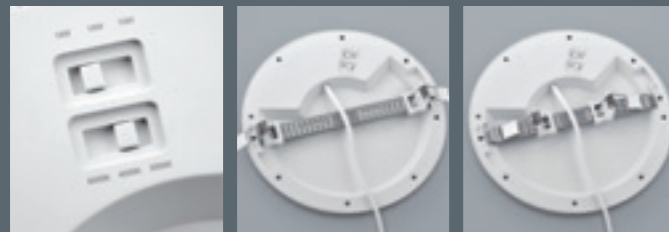

18 W / 15 W / 10 W
3000 K / 4000K / 6500 K
An Deckenausschnitt variabel anpassbar 65 - 205 mm
adjustable to cut-out 65 - 205 mm
einstellbar an der
Leuchte
adjustable
on luminaire





TANA

LED IP44

mattschwarz
Glas teilsatiniert
black mat
glass partially satinised



18 W, 2900 K, B 2220 / N 870 lm, CRI > 90
15/1933.22



22 W, 2900 K, B 2640 / N 1050 lm, CRI > 90
15/1934.22

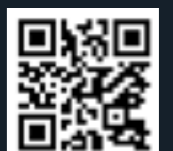



28 W, 2700 K, B 3180 / N 1910 lm, CRI > 80

weiß / white
45/2309.07
schwarz / black
45/2309.22

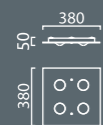

40 W, 2700 K, B 4630 / N 2780 lm, CRI > 80

weiß / white
65/2309.07
schwarz / black
65/2309.22



28 W, 2700 K, B 3180 / N 1910 lm, CRI > 80

weiß / white
45/2319.07
schwarz / black
45/2319.22



BELOS

LED IP20

Muranoglas
Murano glass



www.helestra.de/belos

SIMO



Acrylglas teilsatiniert
acrylic glass partially satinised



25 W, 2700 K, B 2690 / N 1850 lm, CRI > 90

mattweiß / white mat
75/2212.07

mattschwarz / black mat
75/2212.22

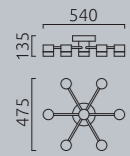

40 W, 2700 K, B 4360 / N 3350 lm, CRI > 90

mattweiß / white mat
115/2212.07

mattschwarz / black mat
115/2212.22

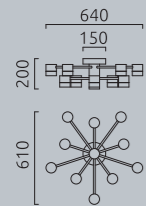



CANIO

E27 IP30

mattweiß
Innenglas opal weiß
white mat
inside glass opal white

1 x E27



Glas klar / glass clear
15/1735.07/5239

Glas grau / glass grey
15/1735.07/5240

Glas amber / glass amber
15/1735.07/5241



PINO





PINO



Kopf verstellbar
Adjustable head

9 W, 2700 K, B 1020 / N 670 lm, CRI > 90

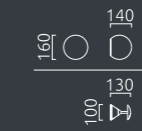

Leuchte ohne Glas / luminaire without glass



messing poliert / brass polished
15/2512.01

chrom / chrome
15/2512.04

roségold / rosegold
15/2512.05

glanzweiß / glossy white
15/2512.08

schwarzchrom / black chrome
15/2512.64

Leuchte mit Glas / luminaire with glass

gewünschtes Glas (klar oder grau) zur Artikel-Nr. hinzufügen
please add desired glass (clear or grey) to article No.

5355 klar / clear
5356 grau / grey

Beispiel für Leuchte messing poliert / Example of polished brass luminaire

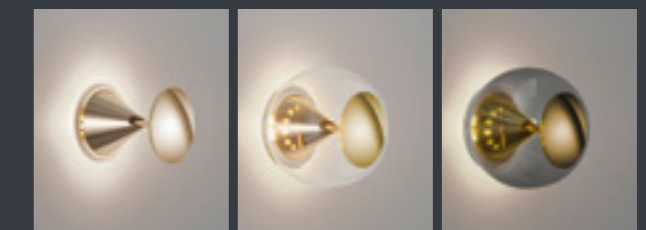

ohne Glas /
without glass
15/2512.01

+ Glas klar /
glass clear
15/2512.01/5355

+ Glas grau /
glass grey
15/2512.01/5356



BUD

LED   IP65

13 W, 2700 K, B 1580 / N 860 lm, CRI > 90

mattweiß / white mat
28/2608.07

coffee
28/2608.70

50 240
140 





LUZ

LED  IP54

Acrylglas satiniert
Leuchtenkopf drehbar
acrylic glass satinised
rotatable luminaire head

9 W, 2700 K, B 1060 / N 850 lm, CRI > 90

mattweiß / white mat
18/2508.07

mattschwarz / black mat
18/2508.22

coffee
18/2508.70

180 115

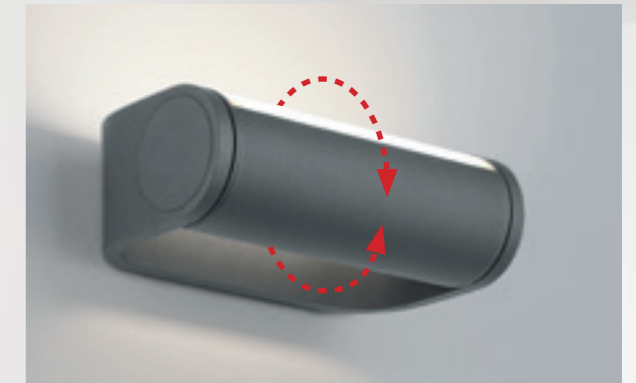

TOCO



12 W, 2700 K, B 1260 / N 880 lm, CRI > 90

mattweiß / white mat

28/2509.07

mattschwarz-mattgold / black mat-gold mat

28/2509.28

coffee

28/2509.70

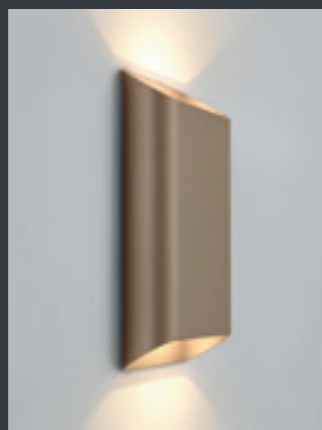
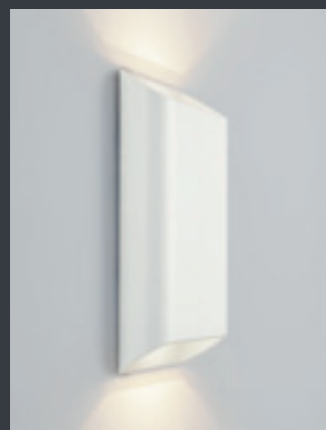

ADEO

LED  IP20

8 W, 2800 K, B 740 / N 490 lm, CRI > 90

mattnickel / nickel mat
18/1807.06

mattweiß / white mat
18/1807.07

200 65





VID

LED   IP65

130° Abstrahlwinkel
130° beam angle

10 W, 2700 K, B 1180 / N 690 lm, CRI > 90



mattweiß / white mat
28/2605.07

mattschwarz / black mat
28/2605.28

coffee
28/2605.70



SIRI

G9 IP20

1 x G9

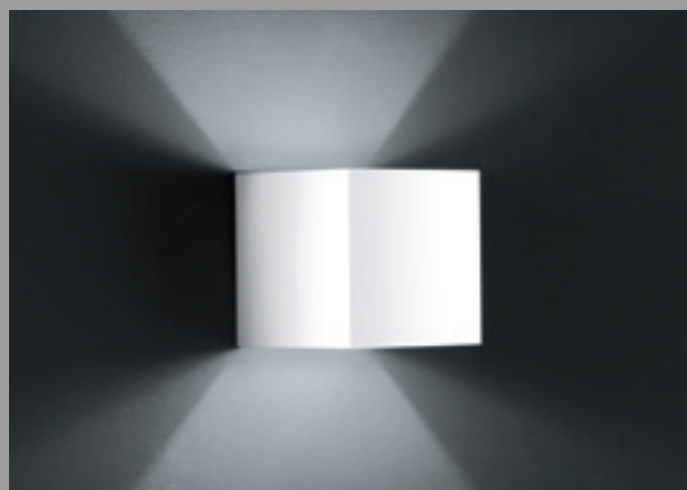

mattweiß
white mat
18/1175.07

100 100
□ □

Optionales Zubehör:
Optional Accessories:



Streuscheibe matt weiß, Glas satiniert
diffuser white mat, glass satinised
5056

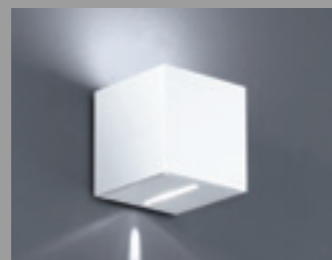

Metallscheibe matt weiß (Schlitz)
slotted metal plate white mat
5057

Leuchtmittel nicht im Lieferumfang
bulb not included



www.helestra.de/siri

175

FOSCA

LED IP20

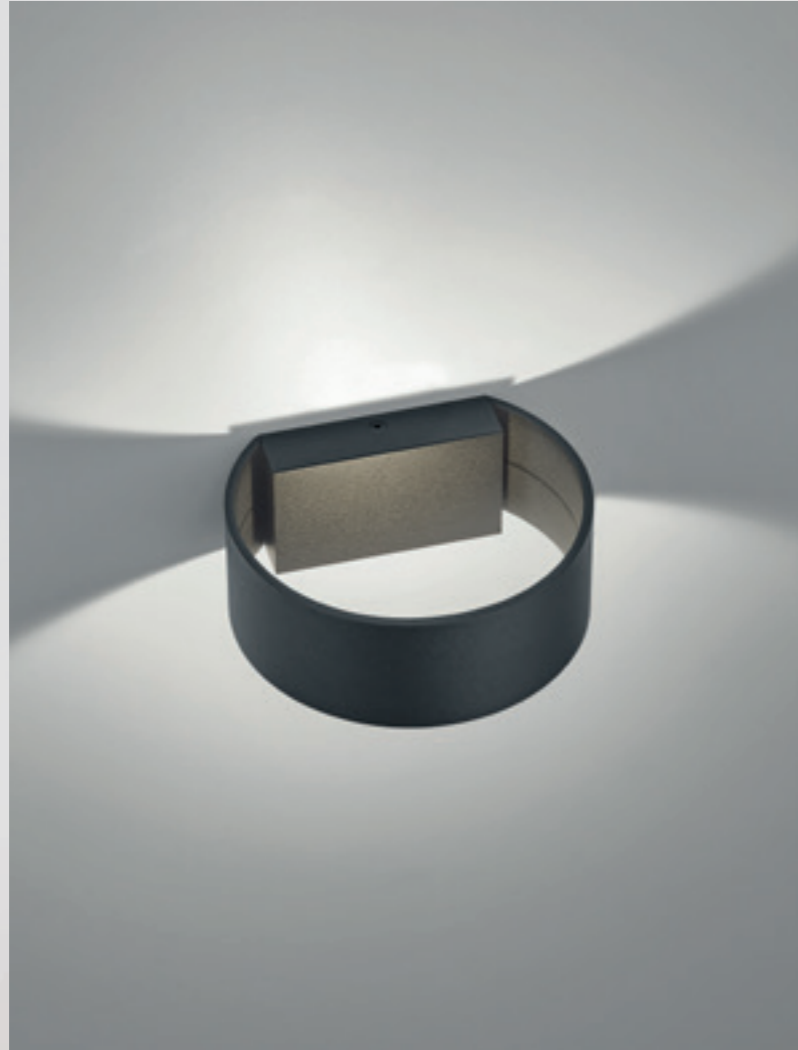

9 W, 2700 K, B 960 / N 580 lm, CRI > 90

mattschwarz / black mat
18/1328.22

mattweiß / white mat
18/1328.07



160
145
60



YONA

LED IP20



15 W, 3000 K, B 1650 / N 1310 lm, CRI > 90

mattweiß / white mat
28/1427.07

aluminium poliert - mattweiß
aluminium polished - white mat
28/1427.25

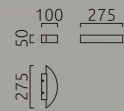



DEX

LED   IP20

aluminium poliert - mattweiß
drehbar
aluminum polished - white mat
rotatable



13 W, 3000 K, B 1480 / N 890 lm, CRI > 90
18/2035.25

270 80
70 H
80 H



NIO



50° Abstrahlwinkel
50° beam angle

12 W, 2700 K, B 1250 / N 730 lm, CRI > 90

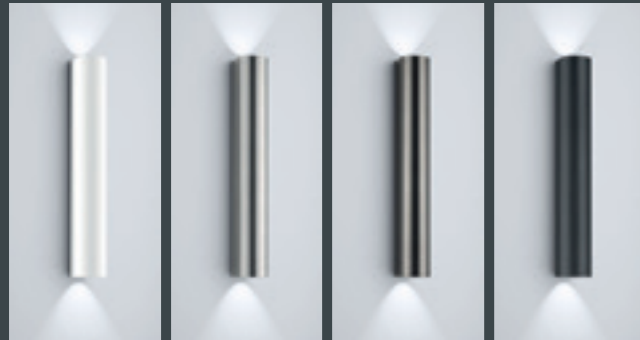

mattweiß / white mat
28/2613.07

mattschwarz / black mat
28/2613.22

aluminium eloxiert / aluminium anodized
28/2613.26

titangrau eloxiert / titanium grey anodized
28/2613.80

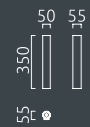

50°



NIO



50° Abstrahlwinkel
50° beam angle

16,5 W, 2700 K, B 1690 / N 1450 lm, CRI > 90



mattweiß / white mat

15/2616.07-...

mattschwarz / black mat

15/2616.22-...

aluminium eloxiert / aluminium anodized

15/2616.26-...

titangrau eloxiert / titanium grey anodized

15/2616.80-...

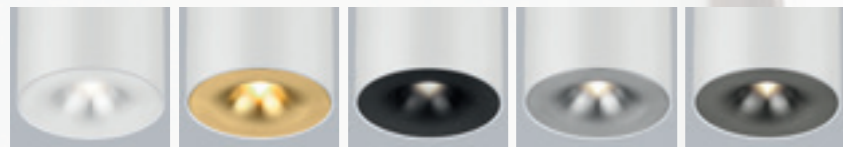

**Farbschlüssel des Reflektors zur Artikelnummer ergänzen
complete item-no. with colour code of lower cover**

...-07 mattweiß / white mat

...-09 mattgold / gold mat

...-22 mattschwarz / black mat

...-26 aluminium eloxiert / aluminium anodized

...-80 titangrau eloxiert / titanium grey anodized



SOU



Acrylglas satiniert
acrylic glass satinised

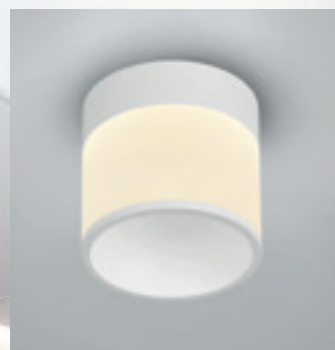

9 W, 2700 K, B 1130 / 1020 lm, CRI > 90

mattweiß / white mat
25/2510.07

mattschwarz / black mat
25/2510.22



18 W, 2700 K, B 2260 / 2040 lm, CRI > 90

mattweiß / white mat
25/2511.07

mattschwarz / black mat
25/2511.22



ENIO



Acryldiffusor satiniert
acrylic diffuser satinised



12 W, 2700 K, B 1310 / N 940 lm, CRI > 90

mattweiß / white mat

	Reflektor / reflector
15/2215.07-07	weiß / white
15/2215.07-09	gold / gold
15/2215.07-22	schwarz / black

mattschwarz / black mat

	Reflektor / reflector
15/2215.22-07	weiß / white
15/2215.22-09	gold / gold
15/2215.22-22	schwarz / black



16 W, 2700 K, B 1670 / N 1390 lm, CRI > 90

mattweiß / white mat

	Reflektor / reflector
15/2216.07-07	weiß / white
15/2216.07-09	gold / gold
15/2216.07-22	schwarz / black

mattschwarz / black mat

	Reflektor / reflector
15/2216.22-07	weiß / white
15/2216.22-09	gold / gold
15/2216.22-22	schwarz / black



28 W, 2700 K, B 2990 / N 2460 lm, CRI > 90

mattweiß / white mat

	Reflektor / reflector
15/2415.07-07	weiß / white
15/2415.07-09	gold / gold
15/2415.07-22	schwarz / black

mattschwarz / black mat

	Reflektor / reflector
15/2415.22-07	weiß / white
15/2415.22-09	gold / gold
15/2415.22-22	schwarz / black

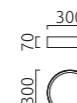

DORA

LED IP20

Glas satiniert
glass satiniert

7,5 W, 2900 K, B 880 / N 510 lm, CRI > 85

mattweiß / white mat

15/1804.07

mattschwarz / black mat

15/1804.22

100
85 □
100 ○

7,5 W, 2900 K, B 880 / N 540 lm, CRI > 85

mattweiß / white mat

15/1805.07

mattschwarz / black mat

15/1805.22

100
85 □
100 ○



KARI

LED  IP30

12 W, 2700 K, B 1180 / N 1030 lm, CRI > 90



mattschwarz / black mat
15/1945.22

mattnickel / nickel mat
15/1945.06

mattweiß / white mat
15/1945.07

120
70
120

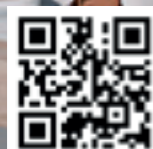



KARI

LED  IP30

12 W, 2700 K, B 1180 / N 1030 lm, CRI > 90



mattschwarz / black mat
15/1946.22

mattnickel / nickel mat
15/1946.06

mattweiß / white mat
15/1946.07

115
□
○



www.helestra.de/kari



RIWA

LED   IP20

Abstrahlwinkel 30°
dreh- und schwenkbar
beam angle 30°
rotatable and tiltable



8 W, 2700 K, B 820 / N 480 lm, CRI > 90

mattweiß / white mat
15/1806.07

mattschwarz / black mat
15/1806.22

120
50 20
Ø 176



24 W, 2700 K, B 2460 / N 1440 lm, CRI > 90

mattweiß / white mat
35/1806.07

mattschwarz / black mat
35/1806.22

120
65
390
Ø 176



GOTO

LED  IP54



Glaslinse klar
dreh- und kipubar
glass lens clear
rotatable and tiltable

8,5 W, 2700 K, B 780 / N 570 lm, CRI > 90



mattweiß / white mat
15/2013.07

mattschwarz / black mat
15/2013.22

70  85
120  120



PAX

LED  IP20

mattweiß
Glas klar
dreh- und schwenkbar
Abstrahlwinkel 12°
white mat
glass clear
rotatable and tiltable
beam angle 12°



230 V - 7,5 W, 2900 K, B 780 / N 560 lm, CRI > 90
15/1808.07

70° 
80° 



230 V - 15 W, 2900 K, B 1560 / N 1120 lm, CRI > 90
25/1808.07

180° 
70° 
80° 



ROTA

LED IP20 YL Plus

dreh- und schwenkbar
rotatable and tiltable



9 W, 2800 K, B 890 / N 620 lm, CRI > 95, 36°

mattweiß / white mat
15/2164.07

mattschwarz / black mat
15/2164.22



15 W, 2800 K, B 1580 / N 1170 lm, CRI > 95, 40°

mattweiß / white mat
15/1964.07

mattschwarz / black mat
15/1964.22



30 W, 2800 K, B 3160 / N 2340 lm, CRI > 95, 40°

mattweiß / white mat
25/1964.07

mattschwarz / black mat
25/1964.22

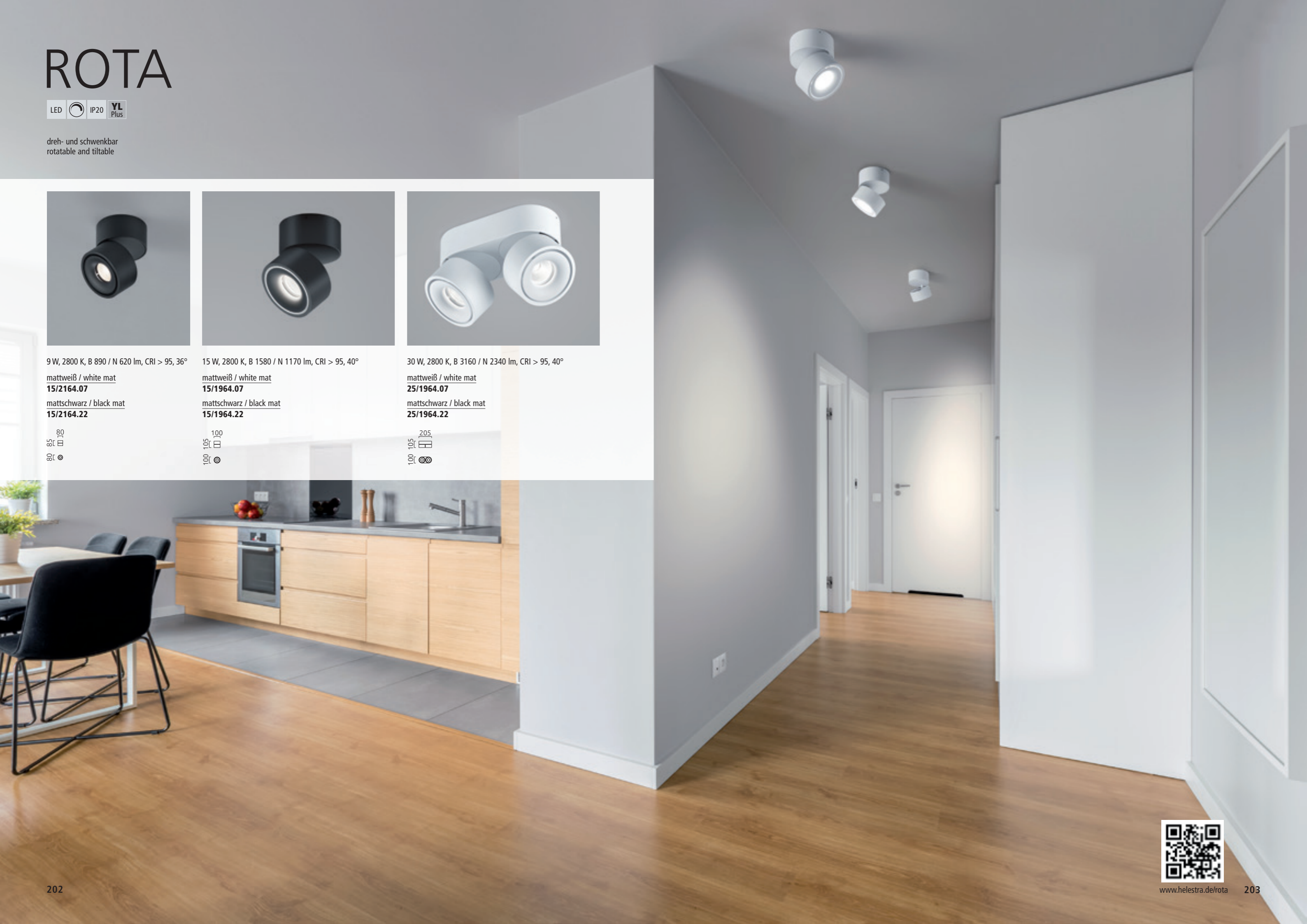

NOG

GU10 IP65 YL
Plus



GU10-LED max. Länge / length 58 mm

mattweiß / white mat

15/2129.07

mattschwarz / black mat

15/2129.22

80
80 □
80 ©

Leuchtmittel nicht im Lieferumfang
bulb not included





TUDO

GU10 IP20 **YL**
Plus

ca. 30° schwenkbar
approx. 30° tiltable

GU10-LED max. Länge / length 58 mm



mattweiß / white mat
15/2329.07

mattschwarz / black mat
15/2329.22

85

100

Leuchtmittel nicht im Lieferumfang
bulb not included



TUDO

GU10 IP20 YL Plus

ca. 30° schwenkbar
approx. 30° tiltable

1 x GU10-LED



mattweiß / white mat

15/2429.07

VPE 4 Stück

15/2429.07-4

mattschwarz / black mat

15/2429.22

VPE 4 Stück

15/2429.22-4



Leuchtmittel nicht im Lieferumfang
bulb not included



ONTO

LED IP20

Einbauleuchte
Lichtaustritt verstellbar
recessed luminaire
light beam adjustable

4 W, 2900 K, B 420 / N 310 lm, CRI > 90
indirekt / uplight



Zum Einbau in Unterputz- Hohlwanddosen
installation in plaster- or cavity wall box



mattweiß / white mat
15/1938.07

aluminium matt / aluminium mat
15/1938.26

62,15 80



SENT

LED IP54

mattweiß
Einbauleuchte
Lichtaustritt verstellbar
white mat
recessed luminaire
light beam adjustable



3 W, 3000 K, B 350 / N 170 lm, CRI > 90
18/2016.07

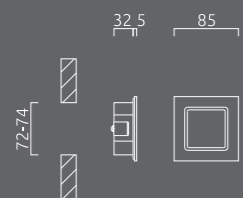

ITO

LED IP20 YL Plus

Einbauleuchte
zum Einbau in Unterputz- / Hohlwanddose
recessed luminaire
installation in plaster- or cavity wall box

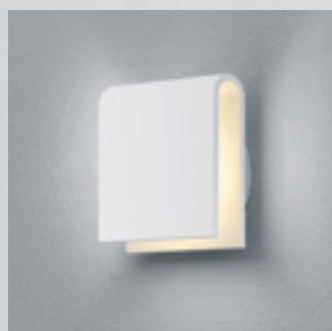

9,7 W, 2700 K, B 980 / N 120 lm, CRI > 85

mattweiß / white mat

18/2411.07

aluminium matt / aluminium mat

18/2411.25

62 35,5 85
E14 E17 E27





SKA

LED   IP20

Einbauleuchte
Glas teilsatiniert
recessed luminaire
glass partially satinised

10 W, 2700 K, B 1060 / N 510 lm, CRI > 90





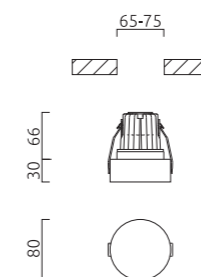

















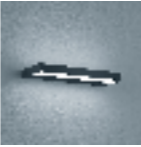
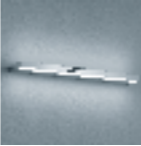
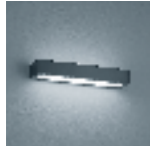





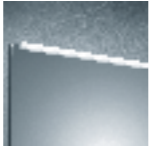







15/2012.00



BATHROOM



Leuchtenübersicht Bathroom
Overview bathroom

<p>DUC 222-223</p> 	<p>VIDO 224-227</p>  	<p>ISOU 228-229</p> 	<p>LOOM 230-237</p>  	<p>LOOM 2 238-239</p> 	<p>PONTO 240-241</p>  	<p>PONTO-S 242-243</p> 	<p>SLATE 244-247</p>  
<p>THEIA 248-251</p>  	<p>NOK 252-253</p> 	<p>LADO 254-255</p>  	<p>LADO-S 256-257</p> 	<p>ONTA 258-259</p> 	<p>GAIA 260-263</p>  	<p>COSI 264-267</p>  	<p>ZELO 268-271</p>  
<p>KYMO 272-273</p> 	<p>KETO 274-275</p>  	<p>OLVI 276-277</p> 	<p>TANA 278-279</p>  	<p>PALA 280-281</p> 	<p>OSO 282-283</p>  	<p>IVA 284-285</p> 	<p>SID 286-287</p> 



INDEX

NEW



DUC

LED    IP44

Acrylglas satiniert
acrylic glass satinised

9 W, 2900 K, B 1060 / N 840 lm, CRI > 95

chrom / chrome

16/2630.04

mattschwarz / black mat

16/2630.22

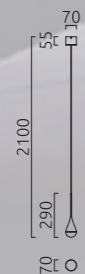

VIDO

LED CCT  IP44

mattschwarz
inkl. Antibeschlag-Heizung
Farbtemperatursteuerung 2700-6500 K

black mat
incl. anti-fog heating
controllable colour temperature 2700-6500 K



27 W, B 2480 / N 1490 lm, CRI > 90
18/2520.22



www.helestra.de/vido



VIDO

LED CCT IP44

mattschwarz
inkl. Antibeschlag-Heizung
Farbtemperatursteuerung 2700-6500 K
black mat
incl. anti-fog heating
controllable colour temperature 2700-6500 K

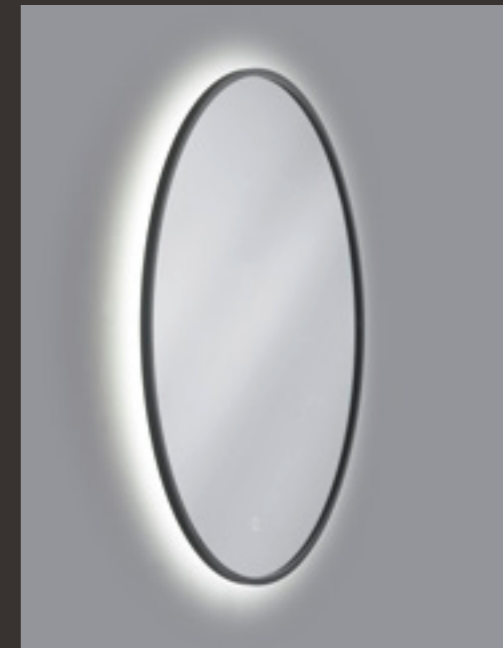

35 W, B 2480 / N 760, CRI > 90
18/2522.22

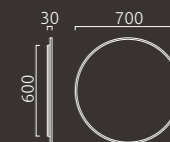

ISOU

LED CCT IP44 YL Plus

Acryldiffusor innen opal / außen klar
Farbtemperatur einstellbar 3000 oder 4000 K
acrylic diffuser opal inside / clear outside
colour temperature adjustable 3000 or 4000 K

12 W, B 1800 / N 1210 lm, CRI > 90

chrom / chrome

18/2420.04

mattschwarz / black mat

18/2420.22

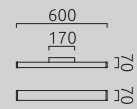

18 W, B 2500 / N 1620 lm, CRI > 90

chrom / chrome

18/2421.04

mattschwarz / black mat

18/2421.22

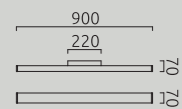

24 W, B 2900 / N 1890 lm, CRI > 90

chrom / chrome

18/2422.04

mattschwarz / black mat

18/2422.22

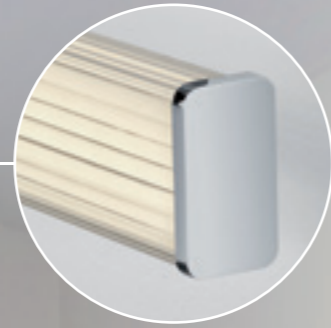
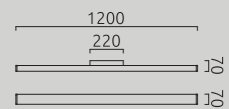

LOOM

LED CCT IP44

chrom
Acrylglas satiniert
Farbtemperatur einstellbar 3000 oder 4000 K
chrome
acrylic glass satinised
colour temperature adjustable 3000 or 4000 K



5,5 W, B 625 / N 500 lm, CRI > 90
18/2020.04



12 W, B 1500 / N 1130 lm, CRI > 90
18/2021.04



18 W, B 2250 / N 1710 lm, CRI > 90
18/2022.04



20 W, B 2750 / N 1990 lm, CRI > 90
18/2023.04



LOOM

LED CCT IP44

mattschwarz
Acrylglas satiniert
Farbtemperatur einstellbar 3000 oder 4000 K
black mat
acrylic glass satinised
colour temperature adjustable 3000 or 4000 K



5,5 W, B 625 / N 500 lm, CRI > 90
18/2020.22

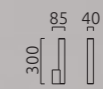

12 W, B 1500 / N 1130 lm, CRI > 90
18/2021.22



18 W, B 2250 / N 1710 lm, CRI > 90
18/2022.22

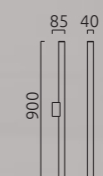

20 W, B 2750 / N 1990 lm, CRI > 90
18/2023.22

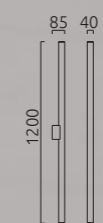



LOOM

LED CCT IP44

mattschwarz
Acrylglas satiniert
Farbtemperatur einstellbar 3000 oder 4000 K
black mat
acrylic glass satinised
colour temperature adjustable 3000 or 4000 K



24 W, B 2850 / N 2170 lm, CRI > 90
25/2621.22



36 W, B 4060 / N 3090 lm, CRI > 90
25/2622.22



40 W, B 4550 / N 3460 lm, CRI > 90
25/2623.22



LOOM

LED CCT IP44

chrom
Acrylglas satiniert
Farbtemperatur einstellbar 3000 oder 4000 K
chrome
acrylic glass satinised
colour temperature adjustable 3000 or 4000 K



24 W, B 2850 / N 2170 lm, CRI > 90
25/2621.04

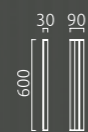

36 W, B 4060 / N 3090 lm, CRI > 90
25/2622.04

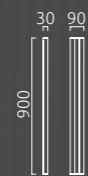

40 W, B 4550 / N 3460 lm, CRI > 90
25/2623.04

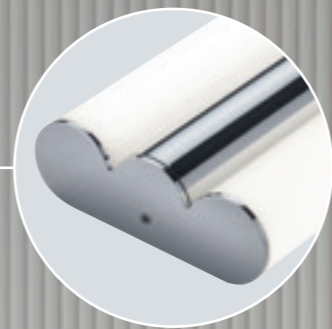
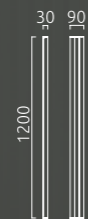

LOOM 2

LED CCT IP44

chrom
Acrylglas satiniert
Farbtemperatur einstellbar 3000 oder 4000 K
chrome
acrylic glass satinised
colour temperature adjustable 3000 or 4000 K



12 W, B 1500 / N 1130 lm, CRI > 90
18/2621.04

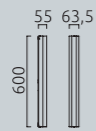

18 W, B 2250 / N 1710 lm, CRI > 90
18/2622.04

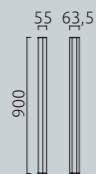

20 W, B 2500 / N 1920 lm, CRI > 90
18/2623.04



PONTO

LED IP44

Acrylglas satiniert
acrylic glass satinised

12 W, 2900 K, B 1280 / N 980 lm, CRI > 90

chrom / chrome

18/1833.04

mattschwarz / black mat

18/1833.22

70 600
D

18 W, 2900 K, B 1920 / N 1460 lm, CRI > 90

chrom / chrome

18/1834.04

mattschwarz / black mat

18/1834.22

70 900
D

24 W, 2900 K, B 2560 / N 1940 lm, CRI > 90

chrom / chrome

18/1835.04

mattschwarz / black mat

18/1835.22

70 1200
D

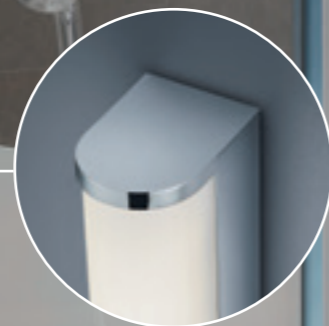

PONTO-S

LED CCT IP44

Acrylglas satiniert
Farbtemperatur einstellbar 3000 oder 4000 K
acrylic glass satinised
colour temperature adjustable 3000 or 4000 K

12 W, B 1280 / 980 lm, CRI > 90

chrom / chrome

18/2533.04

mattschwarz / black mat

18/2533.22

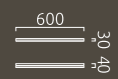

18 W, B 1920 / 1460 lm, CRI > 90

chrom / chrome

18/2534.04

mattschwarz / black mat

18/2534.22



20 W, B 2560 / 1940 lm, CRI > 90

chrom / chrome

18/2535.04

mattschwarz / black mat

18/2535.22



SLATE

LED IP44

mattschwarz
Acrylglas satiniert
black mat
acrylic glass satinised



6,5 W, 2900 K, B 710 / N 360 lm, CRI > 90
18/2037.22



15 W, 2900 K, B 1570 / N 960 lm, CRI > 90
18/2038.22



20 W, 2900 K, B 2130 / N 1260 lm, CRI > 90
18/2039.22

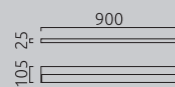

29 W, 2900 K, B 3120 / N 1740 lm, CRI > 90
18/2040.22

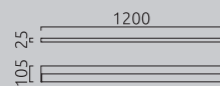

SLATE

LED IP44

chrom
Acrylglas satiniert
chrome
acrylic glass satinised

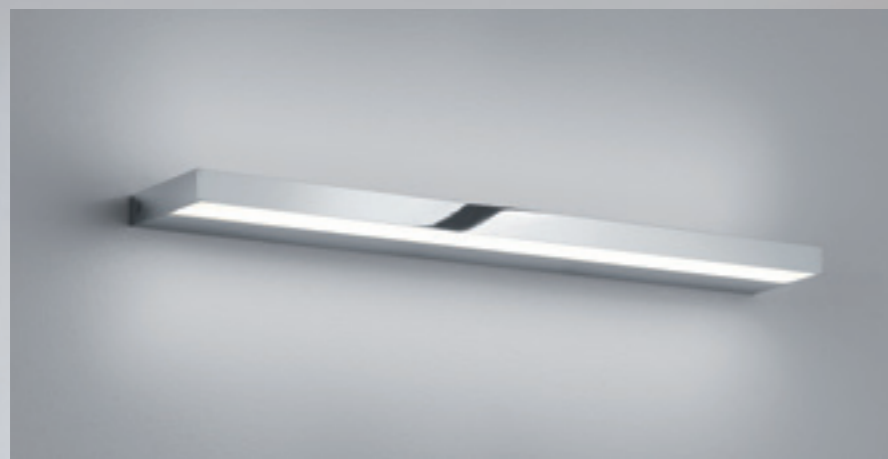

6,5 W, 2900 K, B 710 / N 360 lm, CRI > 90
18/2037.04



15 W, 2900 K, B 1570 / N 960 lm, CRI > 90
18/2038.04

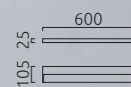

20 W, 2900 K, B 2130 / N 1260 lm, CRI > 90
18/2039.04

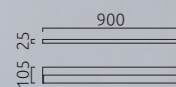

29 W, 2900 K, B 3120 / N 1740 lm, CRI > 90
18/2040.04

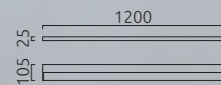

THEIA

LED IP44

mattschwarz
Glas satiniert
Acrylglas satiniert
black matt
glass satinised
acrylic glass satinised

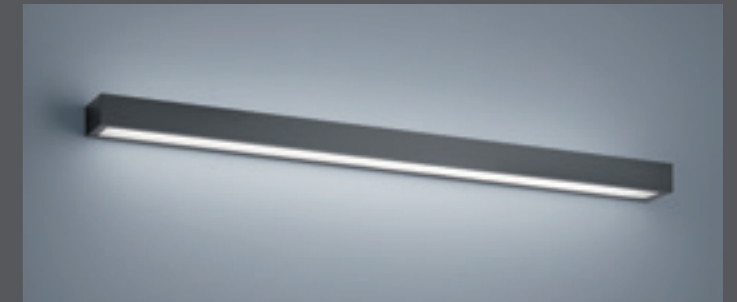

13 W, 2900 K, B 1380 / N 495 lm, CRI > 90
18/1825.22



19 W, 2900 K, B 2110 / N 980 lm, CRI > 90
18/1826.22



25 W, 2900 K, B 2820 / N 1410 lm, CRI > 90
18/1827.22



31 W, 2900 K, B 3540 / N 1800 lm, CRI > 90
18/1828.22



THEIA

LED IP44

chrom
Glas satiniert
Acrylglas satiniert
chrome
glass satinised
acrylic glass satinised



13 W, 2900 K, B 1380 / N 495 lm, CRI > 90
18/1825.04

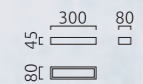

19 W, 2900 K, B 2110 / N 980 lm, CRI > 90
18/1826.04

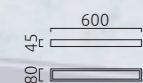

25 W, 2900 K, B 2820 / N 1410 lm, CRI > 90
18/1827.04

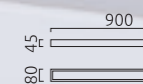

31 W, 2900 K, B 3540 / N 1800 lm, CRI > 90
18/1828.04

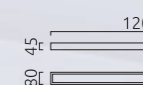

NOK

LED IP44

chrom
Acrylglas satiniert
chrome
acrylic glass satinised

inkl. Zubehör für Wand- oder Spiegelmontage
incl. accessories for wall or mirror mounting



16 W, 2900 K, B 1730 / N 1250 lm, CRI > 90
18/2031.04



25 W, 2900 K, B 2720 / N 2050 lm, CRI > 90
18/2032.04

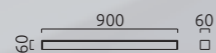

32 W, 2900 K, B 3460 / N 2590 lm, CRI > 90
18/2033.04

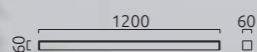

LADO

LED IP44

Acrylglas satiniert
acrylic glass satinised

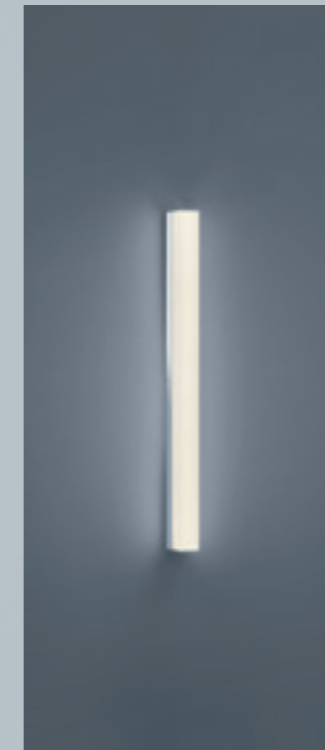
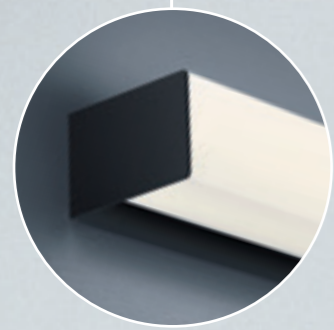

12 W, 2900 K, B 1260 / N 1040 lm,
CRI > 90

chrom / chrome
18/1812.04

mattschwarz / black mat
18/1812.22

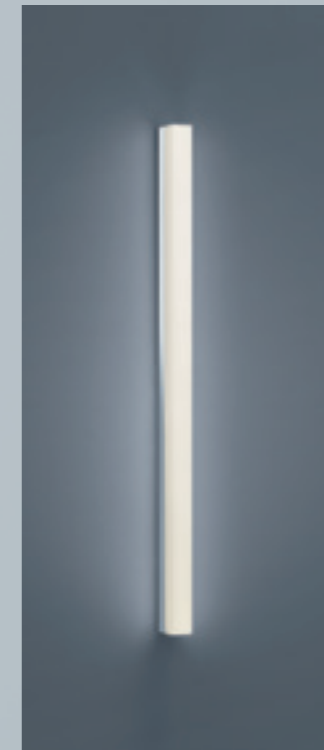
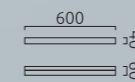

18 W, 2900 K, B 1890 / N 1560 lm,
CRI > 90

chrom / chrome
18/1813.04

mattschwarz / black mat
18/1813.22

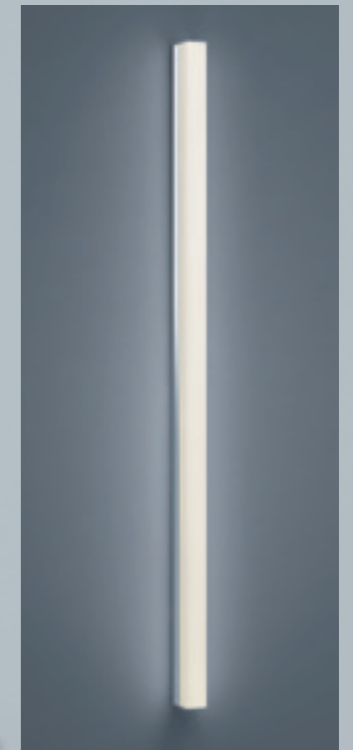
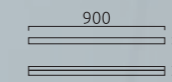

24 W, 2900 K, B 2520 / N 2080 lm,
CRI > 90

chrom / chrome
18/1814.04

mattschwarz / black mat
18/1814.22

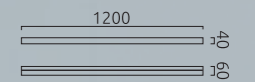

inkl. Zubehör für Wand- oder
Spiegelmontage
incl. accessories for wall or
mirror mounting



LADO-S

LED IP44

Acrylglas satiniert
acrylic glass satinised

12 W, 2900 K, B 1260 / N 1040 lm, CRI > 90

chrom / chrome

18/2423.04

mattschwarz / black mat

18/2423.22

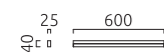

18 W, 2900 K, B 1890 / N 1560 lm, CRI > 90

chrom / chrome

18/2424.04

mattschwarz / black mat

18/2424.22

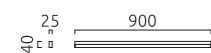

24 W, 2900 K, B 2520 / N 2080 lm, CRI > 90

chrom / chrome

18/2425.04

mattschwarz / black mat

18/2425.22

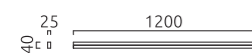

inkl. Zubehör für Wand- oder
Spiegelmontage
incl. accessories for wall or
mirror mounting



ONTA

LED IP44

chrom
Acrylglas satiniert
nur zur Spiegelmontage
chrome
acrylic glass satinised
mirror mounting only



13 W, 2900 K, B 1290 / N 950 lm, CRI > 90
18/2120.04



18 W, 2900 K, B 1890 / N 1430 lm, CRI > 90
18/2121.04



24 W, 2900 K, B 2540 / N 1850 lm, CRI > 90
18/2122.04



GAIA

LED   IP44

chrom
Acrylglas satiniert
inkl. LED-Konverter extern (130x52x13 mm)
Tuneable white 2700 K - 6000 K

chrome
acrylic glass satinised
incl. LED-converter external (130x52x13 mm)
Tuneable white 2700 K - 6000 K



12 W, 2700-6000 K, B 1080 / N 650 lm, CRI > 90
18/1815.04

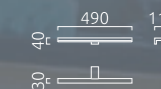

16 W, 2700-6000 K, B 1520 / N 830 lm, CRI > 90
18/1816.04



18 W, 2700-6000 K, B 1760 / N 1070 lm, CRI > 90
18/1817.04



inkl. Zubehör für Wand-, Spiegel- oder Möbelmontage
incl. accessories for wall, mirror or surface mounting



GAIA

LED   IP44

chrom
Acrylglas satiniert
inkl. LED-Konverter extern (130x52x13 mm)
Tuneable white 2700 K - 6000 K

chrome
acrylic glass satinised
incl. LED-converter external (130x52x13 mm)
Tuneable white 2700 K - 6000 K



12 W, 2700-6000 K, B 1080 / N 650 lm, CRI > 90
18/1815.04



16 W, 2700-6000 K, B 1520 / N 830 lm, CRI > 90
18/1816.04

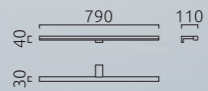

18 W, 2700-6000 K, B 1760 / N 1070 lm, CRI > 90
18/1817.04

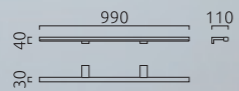

inkl. Zubehör für Wand-, Spiegel- oder Möbelmontage
incl. accessories for wall, mirror or surface mounting



COSI

LED  IP30

Glas satiniert - Kanten poliert
glass satinised - edges polished



10 W, 2900 K, B 1150 / N 660 lm,
CRI > 90

chrom / chrome
18/2005.04

mattnickel / nickel mat
18/2005.06

mattschwarz / black mat
18/2005.22



20 W, 2900 K, B 2660 / N1520 lm,
CRI > 90

chrom / chrome
18/2006.04

mattnickel / nickel mat
18/2006.06

mattschwarz / black mat
18/2006.22





COSI

LED  IP30

Glas satiniert - Kanten poliert
glass satinised - edges polished



7 W, 2900 K, B 1070 / N 610 lm, CRI > 90 

chrom / chrome

15/1905.04

mattnickel / nickel mat

15/1905.06

mattschwarz / black mat

15/1905.22

12 W, 2900 K, B 1780 / N 1020 lm, CRI > 90 

chrom / chrome

15/1906.04

mattnickel / nickel mat

15/1906.06

mattschwarz / black mat

15/1906.22

26 W, 2900 K, B 3220 / N 1840 lm, CRI > 90 

chrom / chrome

15/1907.04

mattnickel / nickel mat

15/1907.06

mattschwarz / black mat

15/1907.22





ZELO

LED IP44

chrom
Acrylglas satiniert
chrome
acrylic glass satinised



12 W, 2900 K, B 1320 / N 820 lm, CRI > 90
15/1950.04

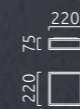

19 W, 2900 K, B 2180 / N 1310 lm, CRI > 90
15/1951.04

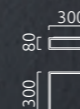



ZELO

LED IP44

chrom
Opalglas satiniert
chrome
opal glass satinised



12 W, 2900 K, B 1460 / N 940 lm, CRI > 90
15/1820.04



18 W, 2900 K, B 2210 / N 1420 lm, CRI > 90
15/1821.04



KYMO

LED IP44

chrom
Glas opal weiß
chrome
glass opal white



12 W, 2900 K, B 1360 / N 940 lm, CRI > 90
15/2124.04



21 W, 2900 K, B 2040 / N 1420 lm, CRI > 90
15/2125.04

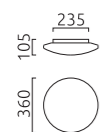

KETO

LED IP44

Opalglas satiniert
opal glass satinised

6 W, 2900 K, B 630 / N 410 lm, CRI > 90



chrom / chrome
15/1822.04

mattschwarz / black mat
15/1822.22

100
125
100



chrom / chrome
15/1823.04

mattschwarz / black mat
15/1823.22

100
125
100



OLVI

LED IP44

chrom
Innenglas Opal weiß
Aussenglas klar
chrome
Internal glass opal white
external glass clear



12 W, 2900 K, B 1320 / N 1020 lm, CRI > 90
15/1931.04



TANA

LED IP44

Glas teilsatiniert
glass partially satinised



18 W, 2900 K, B 2220 / N 870 lm, CRI > 90

chrom / chrome

15/1933.04

mattschwarz / black mat

15/1933.22



22 W, 2900 K, B 2640 / N 1050 lm, CRI > 90

chrom / chrome

15/1934.04

mattschwarz / black mat

15/1934.22





PALA

LED  IP30

Acryldiffusor satiniert
acrylic diffuser satinised

9 W, 2900 K, B 900 / N 725 lm, CRI > 90

mattweiß / white mat
15/1629.07

mattschwarz / black mat
15/1629.22

100 
70 
100 



OSO

LED  IP44

Abstrahlwinkel 40°
beam angle 40°

7,5 W, 2700 K, B 710 / N 370 lm, CRI > 90



Glas klar - opal / glass clear - opal
mattweiß / white mat
15/1553.07

Glas klar-schwarz / glass clear-black
mattschwarz / black mat
15/1553.22



Glas klar - opal / glass clear - opal
mattweiß / white mat
15/1552.07

Glas klar-schwarz / glass clear-black
mattschwarz / black mat
15/1552.22



IVA



Acrylring satiniert
acrylic ring satinised

5 W, 2900 K, B 560 / N 480 lm, CRI > 90



15/2041.00

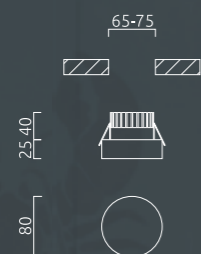



SID

LED   IP65

schwenkbar 20°
 Abstrahlwinkel 60°
 tiltable 20°
 beam angle 60°

11 W, 3000 K, B 1150 / N 890 lm, CRI > 90



mattweiß / white mat
15/2034.07

mattschwarz / black mat
15/2034.22

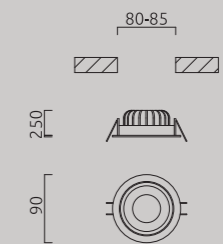



add-it

Das modulare Schienensystem
mit unzähligen Möglichkeiten.

The modular track system with
countless possibilities.

Add-it Schienensystem

Mit unserem modularen Schienensystem bringen wir Licht ins Dunkel! Dekorativ – innovativ – intuitiv!

Dekoratives Licht lässt sich mit dem Add-it System individuell an fast jede Situation anpassen. Eine große Auswahl an Strahlern, Pendelleuchten und Lichtelementen, sowie vielfältige Konfigurationsmöglichkeiten machen es möglich.

Innovative Technik ermöglicht die einfache Installation als reines Aufbausystem (Treiber in der Schiene integriert) und die Dimmung über Funk. Auch eine App-Steuerung ist möglich.

Add-it track system

With our modular track system, we bring light into the dark! Decorative – innovative – intuitive!

Decorative light is easy to adapt to almost any situation with the Add-it system. A great choice of spots, pendant luminaires and light elements as well as numerous configuration options make it possible.

Innovative technology allows for surface-only installation (driver integrated in the track) and wireless dimming, dramatically simplifying the installation. Optional app control is also available.

Nutzen Sie für die Planung Ihres Add-it Systems den Konfigurator auf unserer Homepage.

Use the configurator on our homepage to plan your add-it system.

www.helestra.de/add-it



ADD-IT

Magnetschienen inkl. Endkappen
magnetic tracks incl. end caps

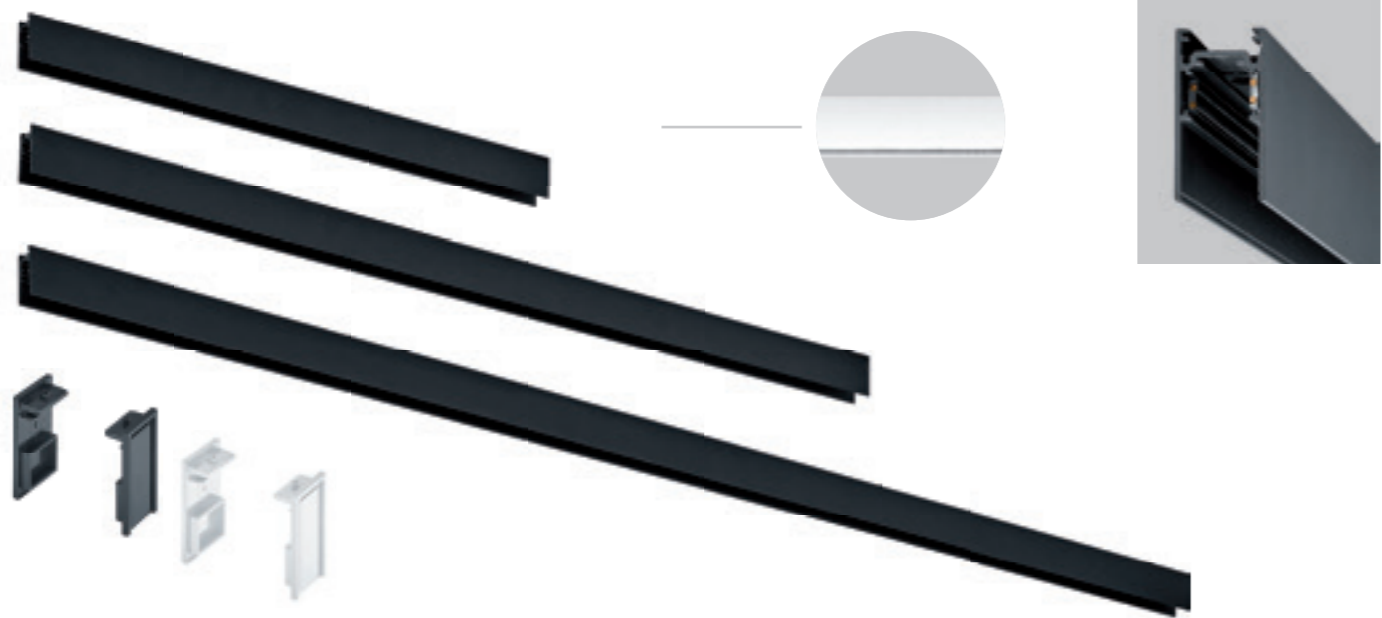
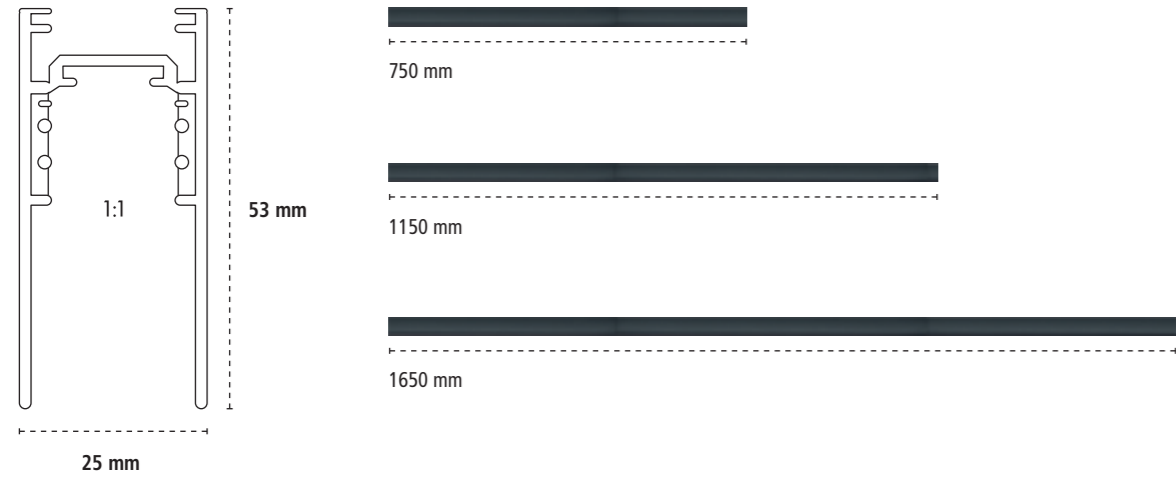

Schiene 750 mm / Track 750 mm
mattweiß / white mat
6650
mattschwarz / black mat
6600

Schiene 1150 mm / Track 1150 mm
mattweiß / white mat
6651
mattschwarz / black mat
6601

Schiene 1650 mm / Track 1650 mm
mattweiß / white mat
6652
mattschwarz / black mat
6602

Schienenabdeckung 1000 mm /
track cover 1000 mm
mattweiß / white mat
6658
mattschwarz / black mat
6608



Abdeckung für Deckenauslass
cover for ceiling outlet
mattweiß / white mat
6606
mattschwarz / black mat
6607

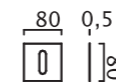

ADD-IT

inkl. elektr. Verbinder
incl. electrical connector



Linienvorbinder / Line connector
mattweiß / white mat
6654
mattschwarz / black mat
6604



90°-Verbinder / 90° connector
mattweiß / white mat
6653
mattschwarz / black mat
6603



T-Verbinder / T-connector
mattweiß / white mat
6659
mattschwarz / black mat
6609

Konverter 100 W
für Schienenbau
Converter 100 W
for rail installation



mattweiß / white mat
6627
mattschwarz / black mat
6621

Konverter 100 W
für externe Einspeisung
Converter 100 W
for external feed



mattweiß / white mat
6626
mattschwarz / black mat
6623

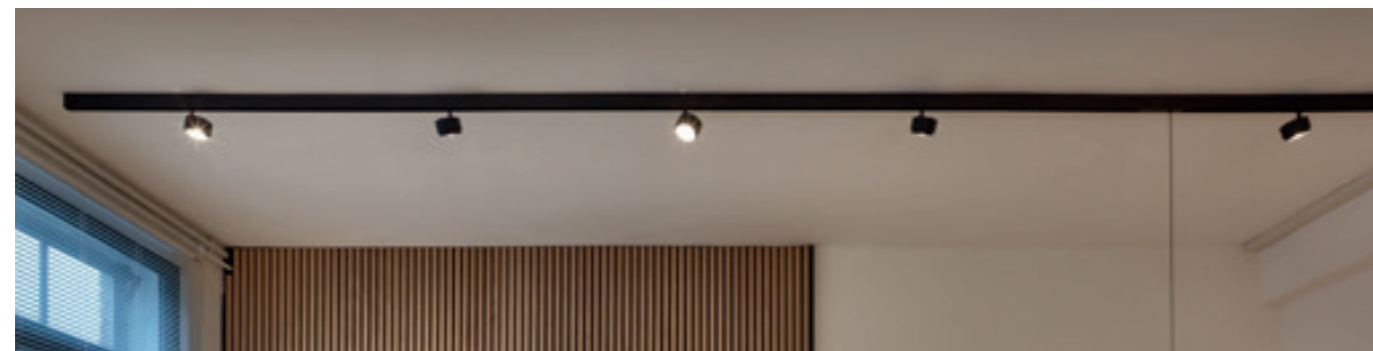

Smart-Home Einbindung möglich. Alle Informationen dazu unter
Smart-home integration is available. All information at
www.helestra.de/add-it



Fernbedienung / remote control
6605

mit Memoryfunktion
with memory function

6610
Smart Controller - Glas weiß
Montage und Anschluss in Standard-
Wandschalterdose. 4 Kanäle können
individuell mit Leuchten, Gruppen oder
Szenen belegt werden.
Die Konfiguration erfolgt über die
HaoDeng-App.
Smart Controller - glass white
Mounting in and wiring in standard
cavity wall box. 4 channels can be
individually assigned with luminaires,
groups or scenes.
The controller is configured by the
HaoDeng-App.



ADD-IT

Alle Leuchten / All luminaires:

2700 K, CRI > 90



Lichtschiene / light bar 305 mm
Acryldiffusor satiniert / acrylic diffuser satinised

7,2 W, B 730 / N 380 lm



mattweiß / white mat
15/2155.07
mattschwarz / black mat
15/2155.22

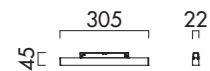

Lichtschiene / light bar 605 mm
Acryldiffusor satiniert / acrylic diffuser satinised

14,4 W, B 1470 / N 760 lm



mattweiß / white mat
15/2156.07
mattschwarz / black mat
15/2156.22



ADD-IT – BALL

8,5 W, B 880 / N 550 lm, 36°

Strahler / spot

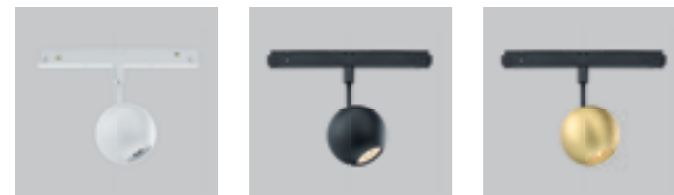

mattweiß / white mat
15/2150.07
mattschwarz / black mat
15/2150.22
mattschwarz-mattgold / black mat-matt gold
15/2150.28

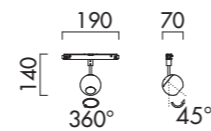

Pendel / pendant



mattweiß / white mat
16/2150.07
mattschwarz / black mat
16/2150.22
mattschwarz-mattgold / black mat-matt gold
16/2150.28

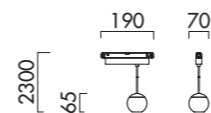

ADD-IT – TUBE

4,5 W, B 520 / N 270 lm, 38°

Strahler / spot



mattweiß / white mat
15/2151.07
mattschwarz / black mat
15/2151.22
mattschwarz-mattgold / black mat-matt gold
15/2151.28

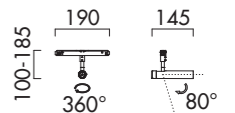

Pendel / pendant



mattweiß / white mat
16/2151.07
mattschwarz / black mat
16/2151.22
mattschwarz-mattgold / black mat-matt gold
16/2151.28

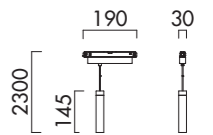

ADD-IT – PONT

10 W, B 960 / N 405 lm

Ausstrahlwinkel verstellbar 15-45°
adjustable beam angle 15-45°

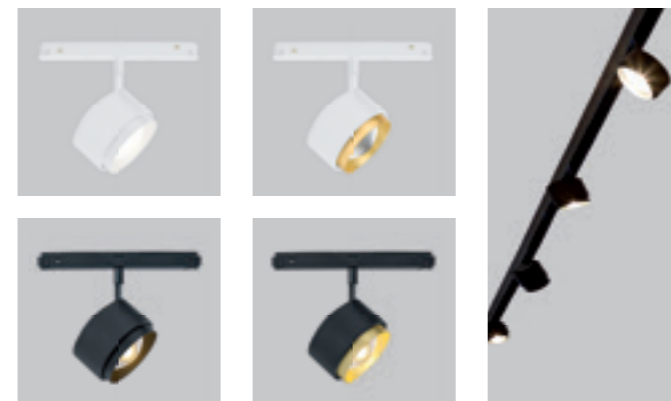

mattweiß / white mat
15/2452.07
mattweiß-mattgold / white mat-gold mat
15/2452.16
mattschwarz / black mat
15/2152.22
mattschwarz-mattgold / black mat-matt gold
15/2152.28

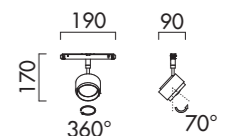

ADD-IT – FLUTE

6 W, B 680 / N 440 lm



mattschwarz / black mat
16/2153.22
Glas klar / Glass clear
16/2153.22/5284
Glas grau / Glass gray
16/2153.22/5285

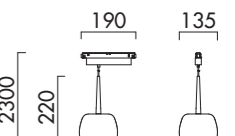

ADD-IT – DEEP
5 W, B 560 / N 450 lm



mattweiß / white mat
16/2154.07
mattschwarz / black mat
16/2154.22
mattschwarz-mattgold / black mat-matt gold
16/2154.28

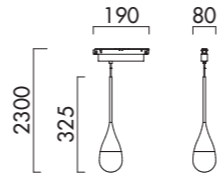

ADD-IT – KOBE
14 W, B 1610 / N 980 lm



mattweiß / white mat
26/2654.07
mattschwarz / black mat
26/2654.22

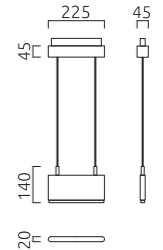

ADD-IT – CONE
5 W, B 560 / N 440 lm



mattweiß / white mat
16/2158.07
mattschwarz / black mat
16/2158.22
mattschwarz-mattgold / black mat-matt gold
16/2158.28

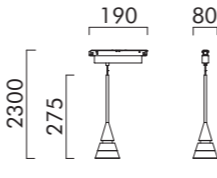

ADD-IT – LETO
6 W, B 440 / N 380 lm

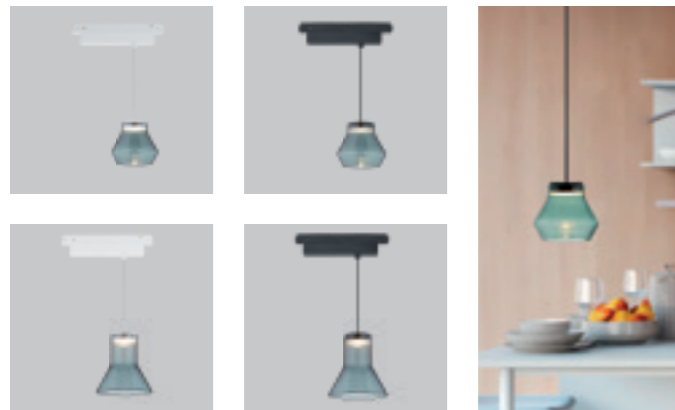

mattweiß / white mat
16/2351.07/5324
mattschwarz / black mat
16/2351.22/5324

mattweiß / white mat
16/2351.07/5325
mattschwarz / black mat
16/2351.22/5325

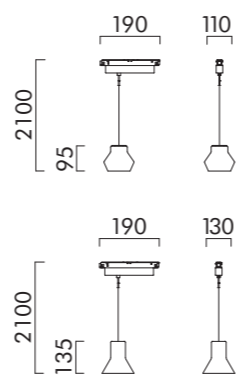

ADD-IT – GLOBE

6 W, B 790 / N 590 lm
mattweiß / white mat
16/2557.07
mattschwarz / black mat
16/2557.22

6 W, B 790 / N 590 lm
mattweiß / white mat
15/2557.07
mattschwarz / black mat
15/2557.22

5 W, B 660 / N 510 lm
mattweiß / white mat
15/2558.07
mattschwarz / black mat
15/2558.22

10 W, B 1320 / N 1020 lm
mattweiß / white mat
25/2558.07
mattschwarz / black mat
25/2558.22

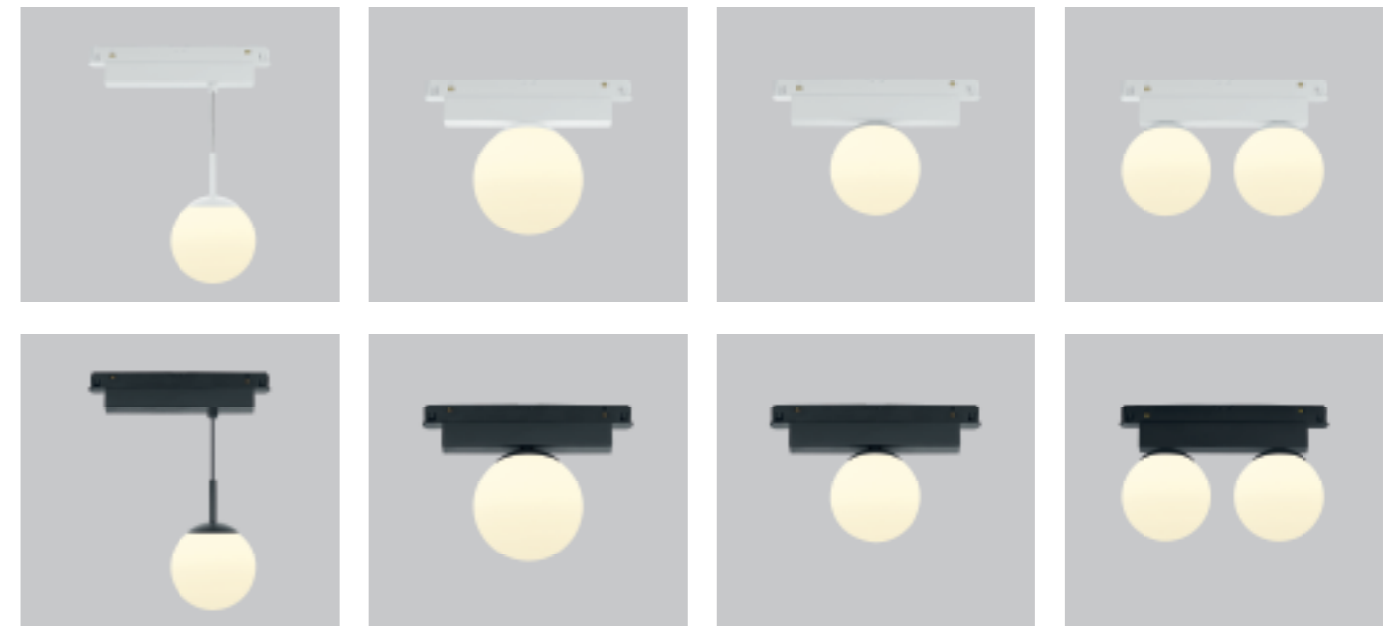

ADD-IT – COPA
6 W, B 440 / N 380 lm



mattweiß / white mat
16/2350.07
mattschwarz / black mat
16/2350.22
mattschwarz-mattgold / black mat-matt gold
16/2350.28

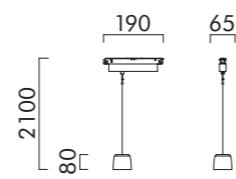



VIGO

THE MODULAR LED SYSTEM

VIGO ist ein modular erweiterbares System, das insbesondere mit seiner minimalistischen Aufbauhöhe, hoher Flexibilität, einfacher Planbarkeit und Montagefreundlichkeit überzeugt. VIGO-Konverter können wahlweise im System integriert oder in Wand bzw. Decken verbaut werden. VIGO ist über die mitgelieferte Fernbedienung komfortabel schalt- und dimmbar.

VIGO is an impressive modular system, capable of being expanded easily and notable for its minimal installation height, high degree of flexibility, and ease of planning and assembly. VIGO drivers can be integrated into your system or built into walls or ceilings. With VIGO you can easily dim the lights or switch them on or off using the remote control device that comes with this product.

Nutzen Sie für die Planung Ihres VIGO-Systems den Konfigurator auf unserer Homepage.

Use the configurator on our homepage to plan your VIGO-system.

www.helestra.de/vigo









VIGO

- System stufenlos dimmbar mit Memory-Funktion
- Steuerung wahlweise über Fernbedienung oder Wandsender
- bis zu 5 Fernbedienungen/Wandsender je System möglich
- eine Fernbedienung/Wandsender für mehrere Systeme möglich
- System infinitely dimmable with memory function
- control optionally by remote control or wall-mounted transmitter
- up to 5 remote controls/wall-mounted transmitters for each system
- one remote control or wall-mounted transmitter can control multiple systems



VIGO

Aufbausystem für Decken
oder Wandmontage
surface mounted ceiling
or wall system
3000 K, CRI > 85



Bestellschritte für Ihr VIGO System. How to configure your VIGO system.

Bitte max. mögliche Gesamtsystemleistung von 100 W beachten.
Please be aware of max. system wattage of 100 W.

Einspeisung power supply		Lichtmodule / Verbinder Light modules / connectors	
1	+	2 extern external	oder/or
		3 intern internally	
		4	+
		5	

Bitte den Farbschlüssel zu den Artikelnummern ergänzen:
Please complete the item number with colour code:

.07 - mattweiß / white mat
.18 - mattnickel eloxiert / nickel mat anodised
.22 - mattschwarz / black mat

Beispiel für mattweiß / example for white mat
6000... 6000.07

1 Konverter inkl. Dimm-Modul und Fernbedienung converter incl. dim-module and remote control



60 W
6020
100 W
6021

Konverter inkl. Dimm-Modul und Wandsender converter incl. dim-module and wall transmitter



60 W
6020.1
100 W
6021.1



* inkl. Magnetbefestigung / * incl. magnetic mount

2 Verbinder* inkl. Kabeleinspeisung (L 900 mm) für extern verbaute Konverter connectors* incl. cable feeder (L 900 mm) for external converters



Endstück / end fitting
6010...



Linierverbinder / line connector
6011...



90°-Verbinder / 90°-connector
6012...



T-Verbinder / T-connector
6013...



3 Deckengehäuse für Konverter housing for converter



Endeinspeisung / end feeder
6030...

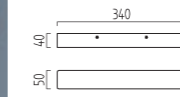

Mittleinspeisung / middle feeder
6031...

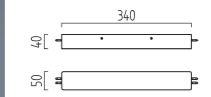

8,2 W, B 940 / N 720 lm



Endeinspeisung / end feeder
25/1730...

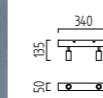

12,2 W, B 1410 / N 1080 lm



Endeinspeisung / end feeder
35/1730...

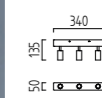

Mittleinspeisung / middle feeder
25/1731...

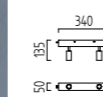

Mittleinspeisung / middle feeder
35/1731...

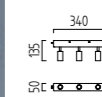

**4 Lineare LED-Module*
linear LED-modules***

Acryldiffusor satiniert
acrylic diffuser satinised

11,5 W, B 1600 / N 1310 lm
15/1600...



18 W, B 2760 / N 2180 lm
15/1601...

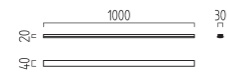

26,5 W, B 4210 / N 3270 lm
15/1602...

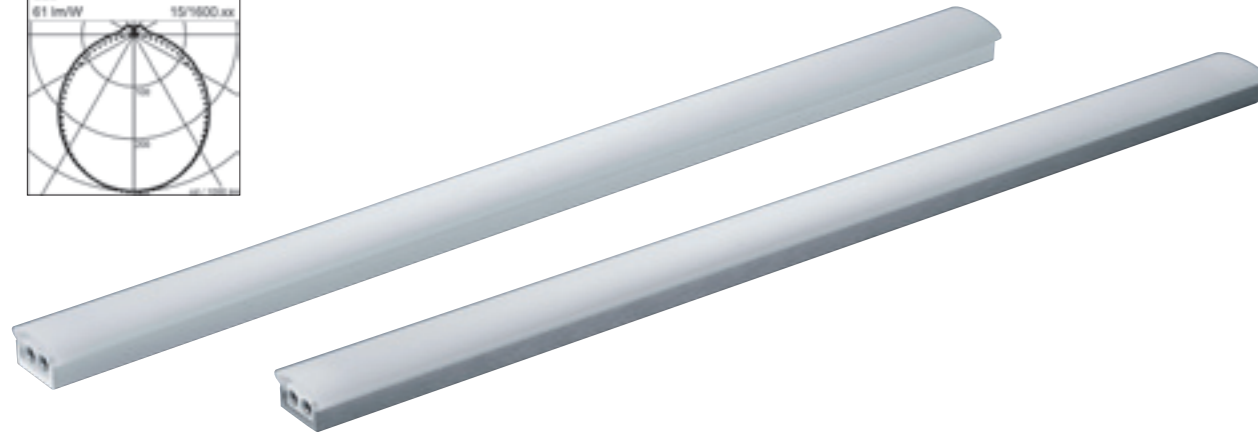
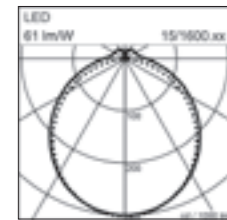
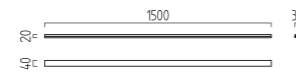

**5 Verbinder*
connectors***



Endstück / end fitting
6000...



Linienverbinder / line connector
6001...



90°-Verbinder / 90°-connector
6002...



T-Verbinder / T-connector
6003...



Verbinder 90° vertikal,
Decke-Wand / Wand-Wand
connector 90° vertical,
ceiling-wall / wall-wall
6004...



* inkl. Magnetbesfestigung / * incl. magnetic mount



**5 LED-Strahlermodule
LED-spotlights**

4 W, B 470 / N 360 lm



Endstück / end fitting
15/1700...



Linienverbinder / line connector
15/1701...



90°-Verbinder / 90°-connector
15/1702...



T-Verbinder / T-connector
15/1703...

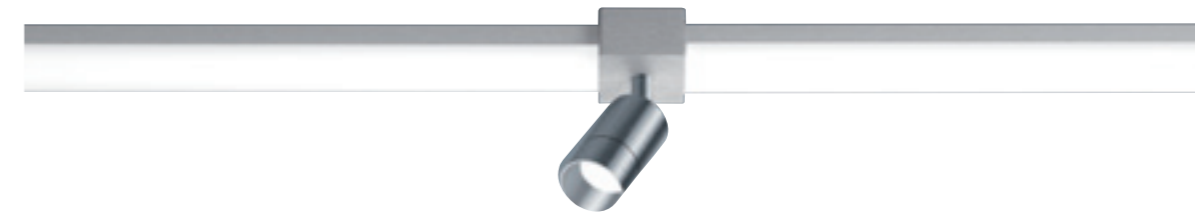

8,2 W, B 940 / N 720 lm



Endelement / end element
25/1730...

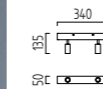

Mittелеlement / middle element
25/1731...

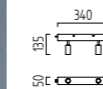

12,2 W, B 1410 / N 1080 lm



Endelement / end element
35/1730...

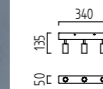

Mittелеlement / middle element
35/1731...

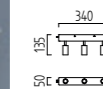

LIGHT IS OUTSIDE[®]



Leuchtenübersicht Außenleuchten
Overview outdoor lighting

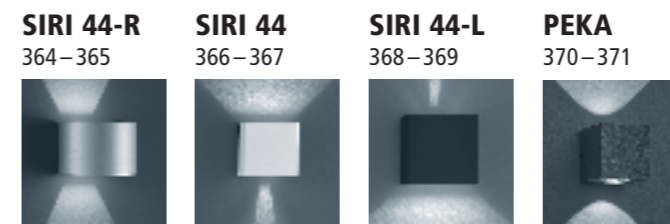
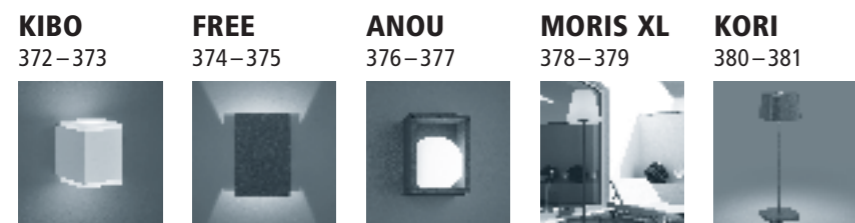
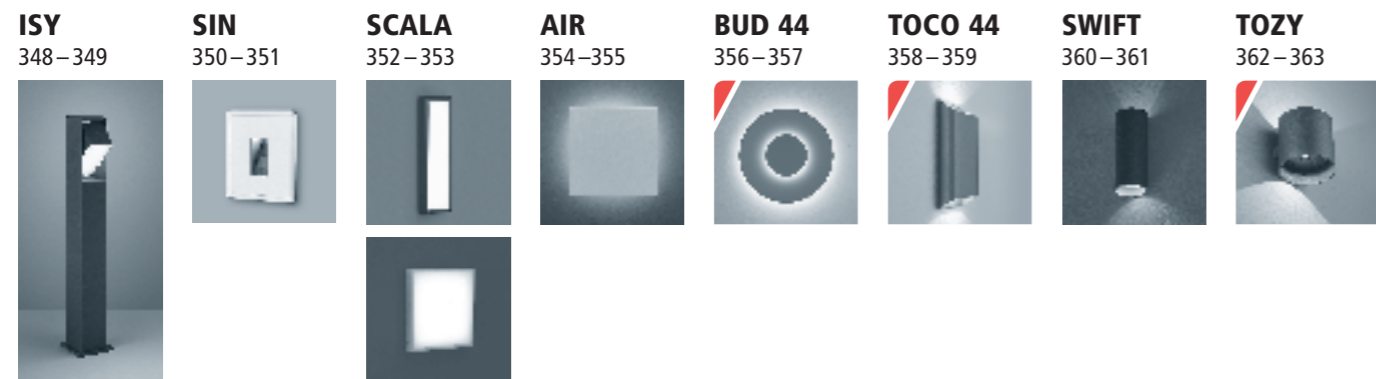

INDEX

NEW

LIGHT IS OUTSIDE

BICA-Q

LED IP65 IK08 YL Plus

Aluminium Druckguss
graphit
Linse UV-beständig für breitstrahlende Lichtverteilung
die casting aluminium
graphite
uv resistant lens for wide beam

24 W, 3000 K, B 2700 / N 1160 lm, CRI > 85
A192303.93



Zubehör für Bodenbefestigung
accessories for floor assembly
Seite / page 383



BICA-R

LED IP65 IK08 YL Plus

Aluminium Druckguss
graphit
Linse UV-beständig für breitstrahlende Lichtverteilung
die casting aluminium
graphite
uv resistant lens for wide beam

24 W, 3000 K, B 2700 / N 1160 lm, CRI > 85
A192301.93

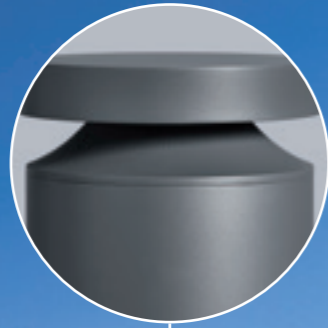

Zubehör für Bodenbefestigung
accessories for floor assembly
Seite / page 383



BICA

LED IP65 IK07 YL Plus

Aluminium Druckguss
graphit
Glasabdeckung klar
Abstrahlwinkel 36°
die casting aluminium
graphite
glass cover clear
beam angle 36°

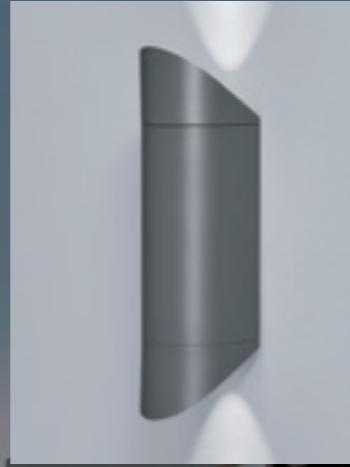

24 W, 3000 K, B 2700 / N 1320 lm, CRI > 85
A282305.93



Blende, 2er-Set / glare shield, set of 2
9050



BICA

LED IP65 IK05 YL Plus

Aluminium Druckguss
graphit
Glasabdeckung klar
Abstrahlwinkel 48°
die casting aluminium
graphite
glass cover clear
beam angle 48°

13 W, 3000 K, B 1380 / N 1020 lm, CRI > 85
A152306.93



25 W, 3000 K, B 2830 / N 2090 lm, CRI > 85
A152307.93

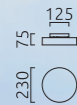

Montage flach an der Decke oder abgesetzt mit
Distanzring möglich
installation flush to ceiling or with spacer plate



POSH

LED IP65

Aluminium Druckguss
Glaslinse klar
die-casting aluminium
glass lens clear

230 V - 6 W, 3000 K, B 520 / N 320 lm, CRI > 85



graphit / graphite
A152005.93

mattweiß / white mat
A152005.07

Ø 52
H 10

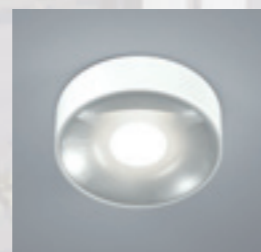

www.helestra.de/posh

325

LUZ 44



LED  IP54

graphit
Acrylglas satiniert
Leuchtenkopf drehbar
graphite
acrylic glass satinised
rotatable luminaire head

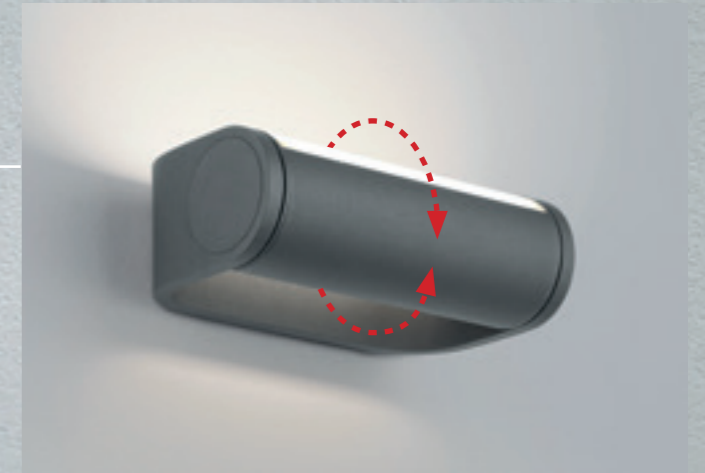
9 W, 2700 K, B 1060 / N 850 lm, CRI > 90



A182408.93

60°  180°  115° 





LUZ 44

LED  IP54

graphit
Acrylglas satiniert
Leuchtenkopf drehbar
graphite
acrylic glass satinised
rotatable luminaire head

9 W, 2700 K, B 1060 / N 850 lm, CRI > 90

A192408.93

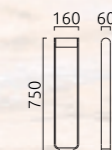

Zubehör für Bodenbefestigung
accessories for floor assembly
Seite / page 383

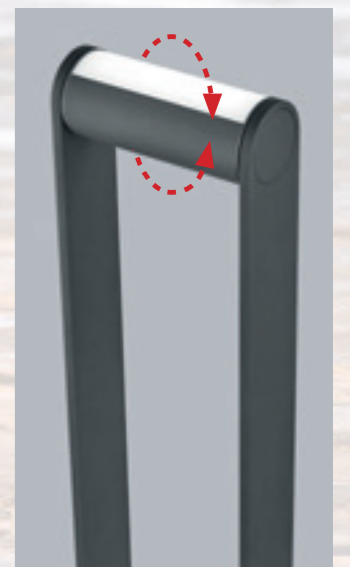

NORSA

LED IP54 YL Plus

Aluminium
graphit
kippar
aluminium
graphite
tiltable

A192203.93

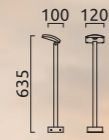

10,5 W, 3000 K, B 1080 lm /
N 710 lm, CRI > 90

A182203.93

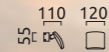

Zubehör für Bodenbefestigung
accessories for floor assembly
Seite / page 383



OKI

LED IP54

Aluminium massiv
Acrylglas satiniert
solid aluminium
acrylic glass satinised

25 W, 3000 K, B 2810 / N 1360 lm, CRI > 85

graphit / graphite
A19803.93



Zubehör für Bodenbefestigung
accessories for floor assembly
Seite / page 383



OKI

LED  IP54

Aluminium massiv
Acrylglas satiniert
solid aluminium
acrylic glass satinised

8 W, 3000 K, B 880 / N 520 lm, CRI > 85

graphit / graphite
A18803.93

160 170





CILA

LED IP65 YL Plus

Aluminium
graphit
Acryl satiniert
schwenkbar
aluminium
graphite
acrylic satinised
tiltable

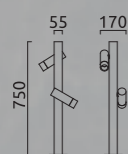
12 W, 3000 K, B 1260 / N 780 lm, CRI > 90
A292201.93



Zubehör für Bodenbefestigung
accessories for floor assembly
Seite / page 383



SKY

LED IP65

graphit
graphite

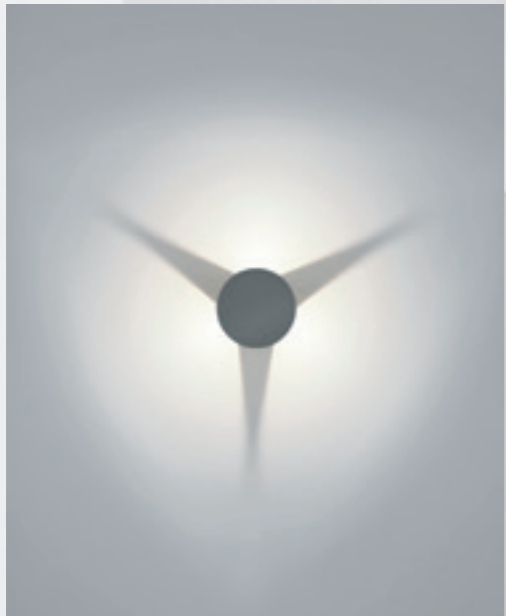

18 W, 3000 K, B 1880 / N 1120 lm, CRI > 90
A382401.93

180 120
☐ ○



SKY

LED IP65

graphit
graphite

18 W, 3000 K, B 1880 / N 1120 lm, CRI > 90
A392401.93

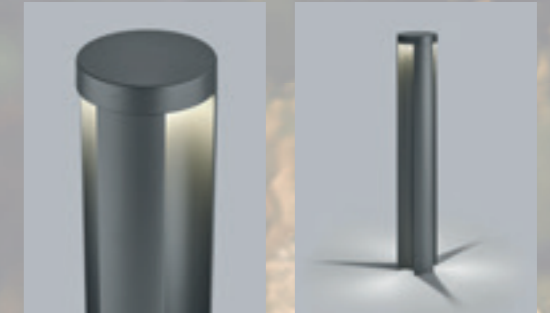
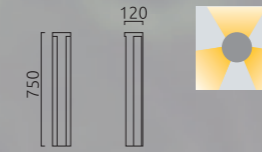

12 W, 3000 K, B 1260 / N 760 lm, CRI > 90
A192401.93



Zubehör für Bodenbefestigung
accessories for floor assembly
Seite / page 383



MONO

LED IP54

Aluminium massiv
solid aluminium

10 W, 3000 K, B 1090 / N 290 lm, CRI > 90

graphit / graphite
A19700.93

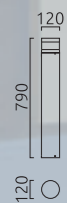

Zubehör für Bodenbefestigung
accessories for floor assembly
Seite / page 383



PIER

LED IP55

Aluminium massiv
graphit
Acryldiffusor satiniert
solid aluminium
graphite
acrylic diffuser satinised

52 W, 3000 K, B 6530 / N 1790 lm,
CRI > 85
A39500.93



Zubehör für Bodenbefestigung
accessories for floor assembly
Seite / page 383



TENDO

LED IP55

Aluminium massiv
graphit
Acryldiffusor satiniert
solid aluminium
graphite
acrylic diffuser satinised



43 W, 3000 K, B 5800 / N 2030 lm, CRI > 80
A29412.93



61 W, 3000 K, B 7540 / N 2640 lm, CRI > 80
A29912.93



Auf Anfrage sind Sonderfarben nach RAL möglich.
Special colours (RAL) on request.

Zubehör für Bodenbefestigung
accessories for floor assembly
Seite / page 383

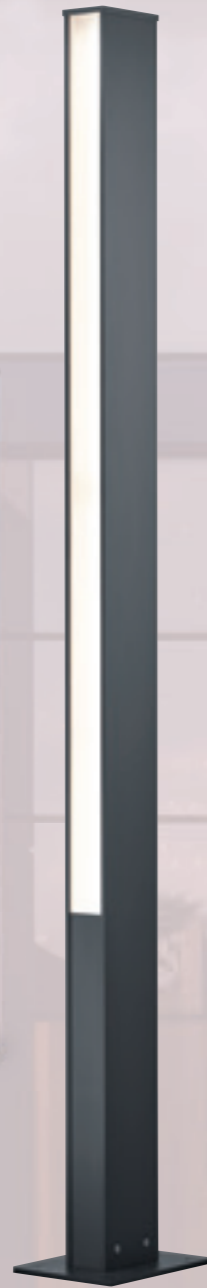

ISY

LED IP54

Aluminium massiv
graphit
Glas satiniert
schwenkbar
solid aluminium
graphite
glass satinised
tiltable

13 W, 3000 K, B 1440 / N 810 lm, CRI > 85
A19901.93

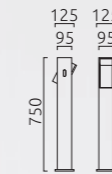

Zubehör für Bodenbefestigung
accessories for floor assembly
Seite / page 383



SIN

LED IP65 IK08 YL Plus

Einbauleuchte - inkl. Montagebox
wall recessed luminaire - incl. installation box

4 W, 3000 K, B 280 / N 170 lm, CRI > 90



mattweiß / white mat
A182308.07

graphit / graphite
A182308.93

105.4 110
105 110

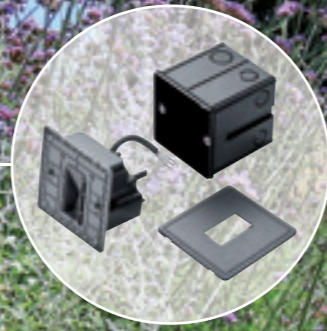



SCALA

LED IP44

Acryldiffusor weiß
acrylic diffuser white

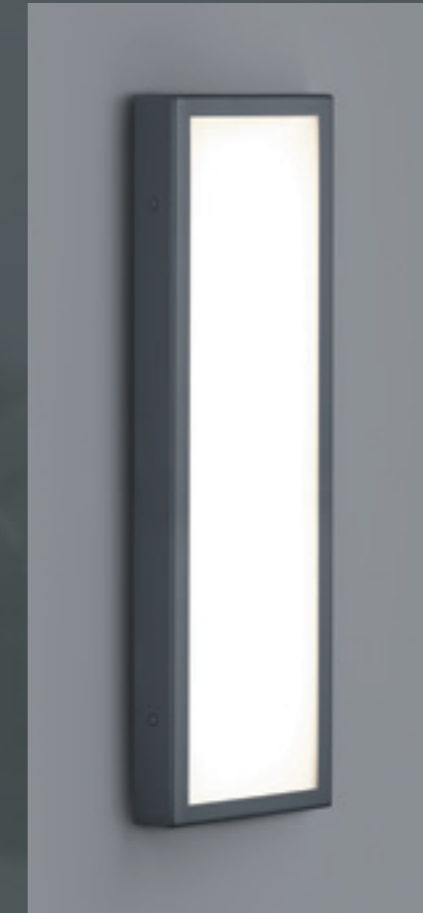

13 W, 3000 K, B 1400 / N 840 lm, CRI > 85

Edelstahl / stainless steel
A18454.86

graphit / graphite
A18454.93



27 W, 3000 K, B 2990 / N 1790 lm, CRI > 85

Edelstahl / stainless steel
A18457.86

graphit / graphite
A18457.93



AIR

LED IP65

Aluminium massiv
solid aluminium

15 W, 3000 K, B 1590 / N 410 lm, CRI > 90



mattweiß / white mat
A18607.07

graphit / graphite
A18607.93

45 150
150 150





BUD 44

LED IP65

13 W, 2700 K, B 1580 / N 860 lm, CRI > 90



graphit / graphite
A282508.93

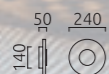



TOCO 44

LED  IP54

12 W, 2700 K, B 1260 / N 880 lm, CRI > 90



graphit / graphite
A282409.93

40 145
200 



SWIFT

LED  IP65

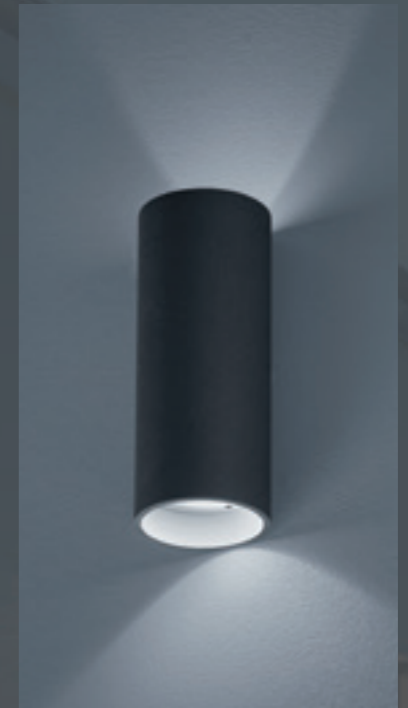

Aluminium massiv
solid aluminium

7 W, 3000 K, B 720 / N 590 lm, CRI > 90

graphit / graphite
A28704.93

75
180
75



TOZY





LED  IP65

120 ° Ausstrahlwinkel
120 ° beam angle

8 W, 2700 K, B 960 / N 610 lm, CRI > 90



graphit / graphite
A282501.93





SIRI 44-R

LED  IP54

Aluminium massiv
solid aluminium

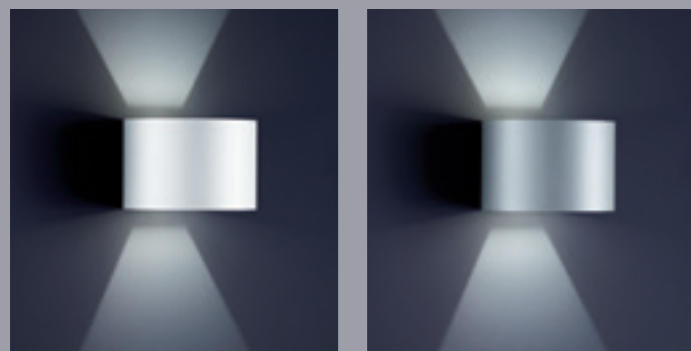
7 W, 3000 K, B 720 / N 390 lm, CRI > 90



mattweiß / white mat
A28342.07

silbergrau / silver grey
A28342.46

mattschwarz / black mat
A28342.93

150
100
125

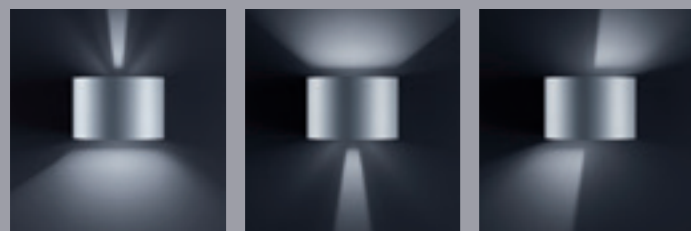

Lichtaustritt stufenlos verstellbar
light beam infinitely adjustable



SIRI 44

LED  IP54

Aluminium massiv
solid aluminium

7 W, 3000 K, B 720 / N 390 lm, CRI > 90

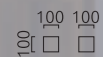
 1,00 1,00
80° □ □

mattweiß / white mat

A28242.07

mattnickel eloxiert / nickel mat anodised

A28242.18

silbergrau / silver grey

A28242.46

graphit / graphite

A28242.73

mattschwarz / black mat

A28242.93

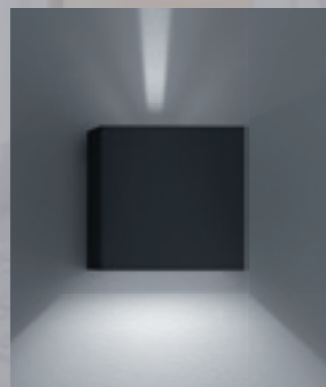
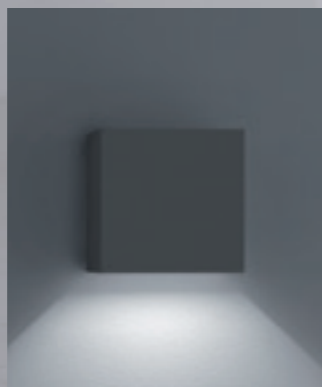
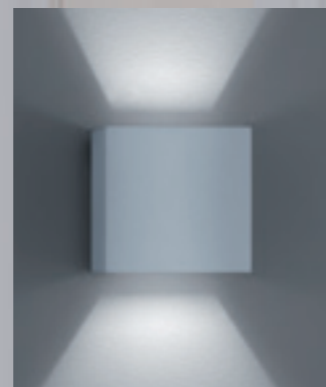
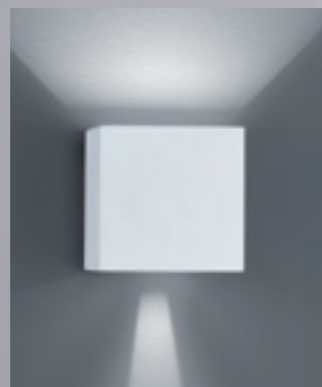

Lichtaustritt stufenlos verstellbar
light beam infinitely adjustable



SIRI 44-L

LED  IP54

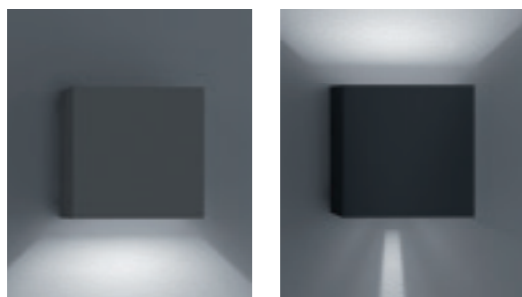
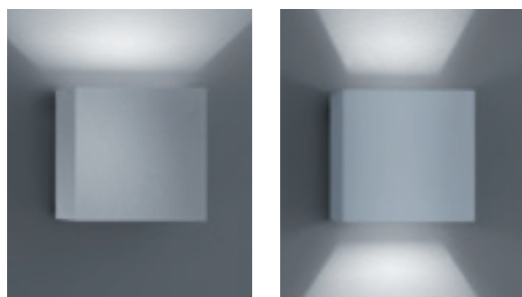

Aluminium massiv
solid aluminium



15 W, 3000 K, B 1550 / N 850 lm, CRI > 90

mattweiß / white mat
A28442.07

mattnickel eloxiert / nickel mat anodised
A28442.18

silbergrau / silver grey
A28442.46

graphit / graphite
A28442.73

mattschwarz / black mat
A28442.93





PEKA

LED IP54

Aluminium massiv
solid aluminium

5 W, 3000 K, B 540 / N 380 lm, CRI > 90



graphit / graphite
A28807.93



KIBO

LED IP54



Aluminium
Acryl weiß
aluminium
acrylic white

11 W, 3000 K, B 1140 / N 520 lm, CRI > 85

mattweiß / white mat
A28612.07

graphit / graphite
A28612.93

90 80
105 □ □





FREE

LED IP54



Aluminium massiv
Lichtaustritt verstellbar
solid aluminium
light beam adjustable

10 W, 3000 K, B 990 / N 520 lm, CRI > 90

graphit / graphite
A18605.93

150 70 100
□ □ □



ANOOU

LED IP65 YL Plus

Aluminium
graphit
Acryl satiniert
aluminium
graphite
acrylic satinised

8,3 W, 3000 K, B 720 / N 590 lm, CRI > 90



A182202.93

170 135 140





MORIS XL

E27  IP44

graphit
witterungsbeständiges Acryl weiß
Zuleitungslänge 3 m
graphite
weather resistant white acrylic
power supply line 3 m

1 x E27

Leuchtmittel nicht im Lieferumfang
bulb not included

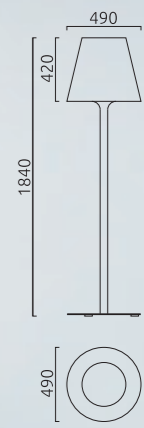

17/2166.93



KORI

LED  IP65

Mobile Akkuleuchte
wiederaufladbar, inkl. USB-Ladekabel
Akku-Laufzeit ca. 8 Std. (100% Lichtleistung)
portable battery light
rechargeable, incl. USB charging cable
battery operating time appr. 8 hrs (100% light intensity)

2,2 W, 2700 K, B 210 / N 120 lm, CRI > 85



mattweiß / white mat
19/2100.07

rostbraun / rubiginous
19/2100.49

mattschwarz / black mat
19/2100.98

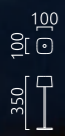

100
100
350





Zubehör Außenleuchten Accessories outdoor lighting

Montage von Pollerleuchten

Alle Pollerleuchten können ohne Zubehör auf einem Fundament verschraubt oder alternativ mit einem Erdstück und einer Adapterplatte gemäß unten stehender Tabelle im Erdboden befestigt werden.

Mounting of bollards

All bollards can be bolted to a solid base without accessories or mounted in-ground with anchorage unit and adapter plate (see list below).

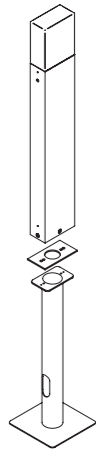

Serie	Erdstück - Stahl verzinkt anchorage unit - steel galvanised	Adapterplatte - Stahl verzinkt adapter plate - steel galvanised
BICA	A19900	9039
CILA	A19900	9037
ISY	A19900	9034
LUZ 44	A19900	9043
MONO	A19900	9029
NORSA	A19900	9038
OKI	A19900	9032
PIER	A19900	9024
SKY A192401	A19900	9041
SKY A392401	A19900	9042
TENDO A29412...	A19900	9018
TENDO A29912...	A19900	9007

A19900

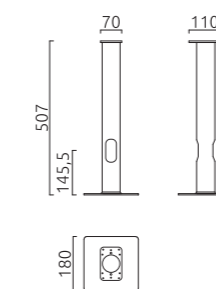

Art.-Nr./art. no.	Seite/page	Art.-Nr./art. no.	Seite/page	Art.-Nr./art. no.	Seite/page	Art.-Nr./art. no.	Seite/page	Art.-Nr./art. no.	Seite/page	Art.-Nr./art. no.	Seite/page	Art.-Nr./art. no.	Seite/page	Art.-Nr./art. no.	Seite/page	Art.-Nr./art. no.	Seite/page
15...		15/2013.07	198	15/2616.07-26	184	16/2600.70	30	18/2410.07-50	131	26...		50...		66/2615.28	53		
15/1552.07	283	15/2013.22	198	15/2616.07-80	184	16/2600.80	30	18/2410.22-07	131	26/1641.27/5210	88	5056	174	66/2615.70	53		
15/1552.22	283	15/2034.07	287	15/2616.22-07	184	16/2601.70	30	18/2410.22-09	131	26/1692.07	123	5057	174	75...			
15/1553.07	283	15/2034.22	287	15/2616.22-09	184	16/2601.80	30	18/2410.22-50	131	26/1692.22	123	52...		75/2212.07	156		
15/1553.22	283	15/2041.00	284	15/2616.22-22	184	16/2630.04	222	18/2411.07	214	26/1792.07	123	5284	70	75/2212.22	156		
15/1600.07	310	15/2124.04	272	15/2616.22-26	184	16/2630.22	222	18/2411.25	214	26/1792.22	123	5285	70	90...			
15/1600.18	310	15/2125.04	272	15/2616.22-80	184	17...		18/2420.04	228	26/1847.04/9276	109	53...		9007	383		
15/1600.22	310	15/2129.07	204	15/2616.26-07	184	17/1240.34/5045	98	18/2420.22	228	26/1847.04/9283	109	5355	163	9018	383		
15/1601.07	310	15/2129.22	204	15/2616.26-09	184	17/1240.34/5096	98	18/2421.04	228	26/1847.04/9288	109	5356	163	9024	383		
15/1601.18	310	15/2150.07	294	15/2616.26-22	184	17/1240.84/5045	98	18/2421.22	228	26/1847.04/9289	109	56...		9029	383		
15/1601.22	310	15/2150.22	294	15/2616.26-26	184	17/1505.19	96	18/2422.04	228	26/1847.04/9290	109	56/2501.22	17	9032	383		
15/1602.07	310	15/2150.28	294	17/1505.22	96	17/1505.22	96	18/2422.22	228	26/2430.07	125	56/2501.70	17	9034	383		
15/1602.18	310	15/2151.07	295	15/2616.80-07	184	17/1849.34/9289	105	18/2423.04	256	26/2430.22	125	56/2503.28	50	9037	383		
15/1602.22	310	15/2151.22	295	15/2616.80-09	184	17/1849.34/9290	105	18/2423.22	256	26/2431.07	125	56/2503.64	50	9038	383		
15/1629.07	281	15/2151.28	295	15/2616.80-22	184	17/2166.93	379	18/2424.04	256	26/2431.22	125	56/2551.22	18	9039	383		
15/1629.22	281	15/2152.22	295	15/2616.80-26	184	17/2310.28	56	18/2424.22	256	26/2502.07	43	56/2551.70	18	9041	383		
15/1632.07	120	15/2152.28	295	15/2616.80-80	184	17/2402.22	34	18/2425.04	256	26/2502.28	43	60...		9042	383		
15/1632.22	120	15/2155.07	294	16...		17/2402.28	34	18/2425.22	256	26/2615.28	53	6000.07	310	9043	383		
15/1700.07	311	15/2155.22	294	16/1504.19	95	17/2501.22	21	18/2508.07	167	26/2615.70	53	6000.18	310	9050	320		
15/1700.18	311	15/2156.07	294	16/1644.19	95	17/2501.70	21	18/2508.22	167	26/2654.07	297	6000.22	310	96...			
15/1700.22	311	15/2156.22	294	16/1847.04/9276	106	17/2507.43	103	18/2508.70	167	26/2654.22	297	6001.07	310	96/2311.22	82		
15/1701.07	311	15/2164.07	202	16/1847.04/9283	106	17/2609.22	23	18/2514.28	133	27...		6001.18	310	115...			
15/1701.18	311	15/2164.22	202	16/1847.04/9288	106	17/2609.70	23	18/2514.28-K	133	27/2311.22	84	6001.22	310	115/2212.07	156		
15/1701.22	311	15/2210.22	149	16/1847.04/9289	106	18...		18/2515.28	133	27/2402.22	34	6002.07	310	115/2212.22	156		
15/1702.07	311	15/2211.22	149	16/1847.04/9290	106	18/1175.07	174	18/2515.28-K	133	27/2402.28	34	6002.18	310	A15...			
15/1702.18	311	15/2215.07-07	188	16/2001.04	70 / 73	18/1328.07	176	18/2520.22	224	27/2606.22	24	6002.22	310	A152005.07	324		
15/1702.22	311	15/2215.07-09	188	16/2001.64	70 / 73	18/1328.22	176	18/2522.22	227	27/2606.70	24	6003.07	310	A152005.93	324		
15/1703.07	311	15/2215.07-22	188	16/2007.22	90	18/1807.06	170	18/2533.04	242	27/2615.28	55	6003.18	310	A152306.93	322		
15/1703.18	311	15/2215.22-07	188	16/2109.02	33	18/1807.07	170	18/2533.22	242	27/2615.70	55	6003.22	310	A152307.93	322		
15/1703.22	311	15/2215.22-09	188	16/2109.22	33	18/1812.04	255	18/2534.04	242	27/2618.22	27	6004.07	310	A18...			
15/1732.07	120	15/2215.22-22	188	16/2110.09	78	18/1812.22	255	18/2534.22	242	27/2618.70	27	6004.18	310	A182202.93	376		
15/1732.22	120	15/2216.07-07	188	16/2110.22	78	18/1813.04	255	18/2535.04	242	28...		6004.22	310	A182203.93	330		
15/1735.07/5239	159	15/2216.07-09	188	16/2150.07	294	18/1813.22	255	18/2535.22	242	28/1427.07	178	6010.07	309	A182308.07	350		
15/1735.07/5240	159	15/2216.07-22	188	16/2150.22	294	18/1814.04	255	18/2621.04	238	28/1427.25	178	6010.18	309	A182308.93	350		
15/1735.07/5241	159	15/2216.22-07	188	16/2150.28	294	18/1814.22	255	18/2622.04	238	28/2330.07-50	128	6010.22	309	A182408.93	327		
15/1800.07/9277	112	15/2216.22-09	188	16/2151.07	295	18/1815.04	261 / 262	18/2623.04	238	28/2330.09-50	128	6011.07	309	A18454.86	353		
15/1800.07/9278	112	15/2216.22-22	188	16/2151.22	295	18/1816.04	261 / 262	19...		28/2330.22-50	128	6011.18	309	A18454.93	353		
15/1800.07/9281	112	15/2254.07	145	16/2151.28	295	18/1817.04	261 / 262	19/1138.10	111	28/2509.07	168	6011.22	309	A18457.86	353		
15/1804.07	190	15/2254.09	145	16/2153.22	295	18/1825.04	251	19/1139.10	111	28/2509.28	168	6012.07	309	A18457.93	353		
15/1804.22	190	15/2254.22	145	16/2153.22/5284	249	18/1825.22	249	19/1943.07	119	28/2509.70	168	6012.18	309	A18605.93	375		
15/1805.07	190	15/2301.22	150	16/2153.22/5285	249	18/1826.04	251	19/2100.07	380	28/2604.07	38	6012.22	309	A18607.07	354		
15/1805.22	190	15/2329.07	207	16/2154.07	296	18/1826.22	249	19/2100.49	380	28/2604.28	38	6013.07	309	A18607.93	354		
15/1806.07	197	15/2329.22	207	16/2154.22	296	18/1827.04	251	19/2100.98	380	28/2605.07	173	6013.18	309	A18803.93	334		
15/1806.22	197	15/2415.07-07	188	16/2154.28	296	18/1827.22	249	19/2402.22	34	28/2605.28	173	6013.22	309	A19...			
15/1808.07	201	15/2415.07-09	188	16/2158.07	296	18/1828.04	251	19/2402.28	34	28/2605.70	173	6020	308	A192203.93	330		
15/1820.04	271	15/2415.07-22	188	16/2158.22	296	18/1828.22	249	19/2507.43	102	28/2608.07	165	6020.1	308	A192301.93	318		
15/1821.04	271	15/2415.22-07	188	16/2158.28	296	18/1833.04	240	19/2611.22	115	28/2608.70	165	6021	308	A192303.93	317		
15/1822.04	274	15/2415.22-09	188	16/2302.07-07	77	18/1833.22	240	19/2631.22	115	28/2613.07	182	6021.1	308	A192401.93	341		
15/1822.22	274	15/2415.22-22	188	16/2302.07-09	77	18/1834.04	240	25...		28/2613.22	182	6030.07	309	A192408.93	329		
15/1823.04	274	15/2416.07	141	16/2302.07-22	77	18/1834.22	240	25/1730.07	309 / 311	28/2613.26	182	6030.18	309	6030.18	342		
15/1823.22	274	15/2416.07-DALI	141	16/2302.22-07	77	18/1835.04	240	25/1730.18	309 / 311	28/2613.80	182	6030.22	309	6030.22	332		
15/1905.04	139 / 267	15/2416.22	141	16/2302.22-09	77	18/1835.22	240	25/1730.22	309 / 311	35...		6031.07	309	A19900	383		
15/1905.06	139 / 267	15/2416.22-DALI	141	16/2302.22-22	77	18/2005.04	264	25/1731.07	309 / 311	35/1730.07	309 / 311	6031.18	309	A19901.93	349		
15/1905.22	139 / 267	15/2417.07	142	16/2306.04/5328	61	18/2005.06	264	25/1731.18	309 / 311	35/1730.18	309 / 311	6031.22	309	A28...			
15/1906.04	139 / 267	15/2417.07-DALI	142	16/2306.22/5329	61	18/2005.22	264	25/1731.22	309 / 311	35/1730.22	309 / 311	61...		A282305.93	320		
15/1906.06	139 / 267	15/2417.22	142	16/2314.22/5326	66	18/2006.04	264	25/1734.07	120	35/1731.07	309 / 311	6100	386	A282409.93	359		
15/1906.22	139 / 267	15/2417.22-DALI	142	16/2314.22/5327	66	18/2006.06	264	25/1734.22	120	35/1731.18	309 / 311	65...		A28242.07	366		
15/1907.04	139 / 267	15/2429.07	208	16/2315.22/5324	74	18/2006.22	264	25/1808.07	201	35/1731.22	309 / 311	65/2309.07	154	A28242.18	366		
15/1907.06	139 / 267	15/2429.07-4	208	16/2315.22/5325	93	18/2007.22	93	25/1964.07	202	35/1806.07	197	65/2309.22	154	A28242.46	366		
15/1907.22	139 / 267	15/2429.22	208	16/2340.22/5045	100	18/2016.07	212	25/1964.22	202	35/1806.22	197	66...		A28242.73	366		
15/1931.04	276	15/2429.22-4	208	16/2340.22/5096	100	18/2020.04	230	25/1994.07	137	6600	290	6600	290	A28242.93	366		
15/1933.04	278	15/2452.07	295	16/2340.22/5097	100	18/2020.22	233	25/1994.09	137	6601	290	6601	290	A282501.93	362		
15/1933.22	153 / 278	15/2452.16	295	16/2340.22/5098	100	18/2021.04	230	25/1994.22	137	6602	290	6602	290	A282508.93	356		
15/1934.04	278	15/2504.07	135	16/2340.75/5045	100	18/2021.22	233	25/2330.07	127	6603	292	6603	292	A28342.07	364		
15/1934.22	153 / 278	15/2504.28	135	16/2340.75/5096	100	18/2022.04	230	25/2330.09	127	6604	292	6604	292	A28342.46	364		
15/1938.07																	



Infos & téléchargements

nova-tech.shop/frameled
bonjour@nova-tech.shop
01 88 606 606